

Contents

1 Introduction	2
1.1 General characteristics	2
2 Codes of instruments and accessories	2
2.1 FCM* codes	2
2.2 Accessories	2
3 Buttons and displayed indications	3
3.1 Front panel.....	3
4 Installation	4
4.1 Mounting the instrument	4
4.2 Electrical connections.....	4
5 Functions	5
5.1 Serial option.....	5
6 Programming and configuring the FCM*	6
6.1 Standard configuration.....	6
6.2 Initialisation of FCM* instruments	6
6.3 Auxiliary functions	7
6.4 High and Low alarms (not available in slave mode).....	8
6.5 Defrosting (not available in SLAVE mode).....	8
6.6 Multifunction digital inputs	9
6.7 Multi-function digital output.....	10
6.8 Extra LED indicators.....	10
7 Programming FCM controllers	11
7.1 Setting the set-point ("St" parameters).....	11
7.2 Accessing "P" parameters	11
7.3 Accessing "C" parameters	11
7.4 Validity of the modifications.....	12
7.5 Displaying the unit of measure	12
7.6 Setting min. and max. output values	12
7.7 Factory-set parameters.....	13
7.8 Remote Control	13
7.9 Technical specifications.....	13
7.10 Description of the keypad	13
7.11 Using the remote control.....	14
7.12 Setting the access code	14
8 Description of the parameters	15
8.1 Parameters concerning the set-point.....	15
8.2 Parameters concerning the analogue output.....	16
8.3 Parameters concerning inputs	18
8.4 Alarm parameters.....	19
8.5 Parameters concerning digital inputs and output	20
8.6 Parameters concerning the unit of measure	21
8.7 Parameters concerning defrost	23
8.8 Parameters concerning keypad and remote control	24
8.9 Parameters concerning serial connection	25
9 Table of Parameters	27
10 Alarms	31
11 Technical specifications	32
12 Wiring diagram	33
12.1 Terminal block	33
12.2 Power supply:.....	33
12.3 Connecting probes	34
13 Dimensions	35

1 Introduction

The electronic controls of FCM series have been designed to manage the main physical values (temperature, pressure, humidity) in air-conditioning, refrigeration and heating units.

1.1 General characteristics

There are 3 models available, which differ according to the type of analogue input (probe).

Adaptability: continuous or On/Off-type regulatory controls.

Serial option: the FCM controls are designed to allow connection to supervisory or pLAN networks (local area networks made up of pCO controllers).

Accessories: a serial interface board (FCSER00000) which is fitted inside the control and Infrared remote control for programming functions is available on request.



Certification: CE mark, ISO 9001 certified design and production system.

Applications: although being designed for general use, the FCM series devices are particularly effective as condensation temperature controls, as they control fan speed in condensation units.

In this situation, special devices are used to power the fans proportionally to the signal from the FCM control.

There is a variety of such power devices available (multi-step transformer, phase cut, frequency converter). CAREL, in particular, has developed a family of phase cutting power devices, specially designed for this type of application. Ask Carel for further information.

2 Codes of instruments and accessories

2.1 FCM* codes

Model	Code
2-input control for NTC probes	FCM00NTC00
2-input control for probes with 0÷10 V voltage output	FCM0001000
2-input controller for probes with 0÷20 mA or 4÷20 mA current output	FCM0002000

2.2 Accessories

Serial interface	Code
Two-wires RS485 serial interface option	FCSER00000

Infrared remote control	Code
Language	Code
ENGLISH	IRTRFC0E00

Probes

Model	Code
Carel NTC temperature probes	NTC*
0÷25 bar pressure probes, 4÷20 mA output	SPK2500000
0÷30 bar pressure probes, 4÷20 mA output	SPK3000000

3 Buttons and displayed indications

3.1 Front panel

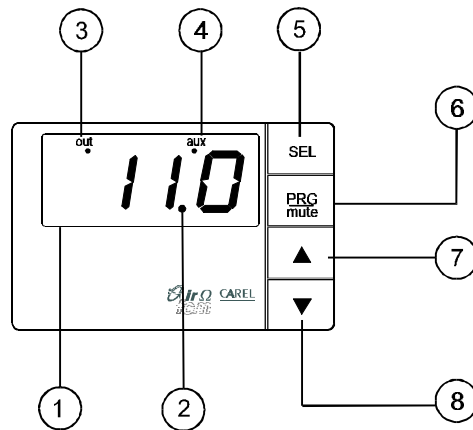

Fig. 1

1 - Display:

- it displays the value of the connected probes or the status of the control, as programmed (parameter C33);
- in the event of alarm, it displays the alarm code;
- during the programming it displays the parameter codes and their values.

2 - LED decimal:

- it turns on when the value being controlled is displayed with decimal point resolution.

3 - LED OUT:

- it turns on when the 0÷10 V output energises (output voltage different from 0 V);
- it flashes when the 0÷10 V output reaches its maximum programmed value.

4 - LED AUX:

- it turns on or flashes according to the selected operating mode.

5 - button:

- displays and/or sets the set-point; if pressed together with the PRG/mute  button for 5 seconds, it allows the password to be inserted and the configuration parameters to be accessed (parameters with code "Cxx").

6 - button:

- if pressed for 5 seconds, it allows the more frequently used parameters to be accessed (parameters with code "Pxx");
- in the event of alarm it silences the buzzer; if pressed again, resets the alarm signal, as long as the cause of the alarm has been removed.

7 - ▲ button:

- while being pressed it displays the value of probe 1;
- during the programming it moves to the next parameter or increases the value of the parameter.

8 - ▼ button:

- while being pressed it displays the value of probe 2;
- during the programming it moves back to the previous parameter or decreases the value of the parameter.

4 Installation

4.1 Mounting the instrument

- 1) **Connect probes and power:** probes can be placed up to 100 m distant from the controller provided that you use 1mm² cross-section, possibly shielded, cables to increase immunity against noises.
- 2) **Program the control** following the instructions in the “Programming” section.
- 3) **Connect the actuators:** the actuators should only be connected after having programmed the control.

Note: the maximum load values for inputs and outputs should be respected, as indicated in the “Technical specifications” section. As far as the actuator connected to the 0÷10 V output is concerned, the same indications listed below regarding the probes on distances and precautions should be followed.

- 4) **Serial network connection:** if connection to a supervisory or pLAN network is required, the optional serial interface boards (cod. FCSE00000), should be inserted in the control. Before performing this operation, make sure power has been disconnected, and then follow the instructions enclosed with the interface board. It is necessary to take care of the system grounding. Especially, the secondary of the control supply power transformers must not be connected to earth. If it may be necessary to connect a transformer to a secondary on earth, an insulating transformer must be interposed. It is possible to connect more instruments to the same insulating transformer keeping the same correspondence between the “G” and the “G0” of the various instruments; however it is advisable to use a single insulating transformer for each instrument.

Before carrying out the operation, make sure that the power supply has been removed, then follow the instructions enclosed to the Serial board.

4.2 Electrical connections

Before performing any electrical connections, the instructions and drawings on the following pages **must** be carefully observed. Furthermore, the unit **must** be used complete with all required electromechanical safety devices in order to guarantee **total safety** for the operator.

WARNING:

Avoid installing the controls in environments which present the following characteristics:

1. Non-condensing relative humidity above 90%;
2. Strong vibrations or shocks;
3. Exposure to jets of water;
4. Exposure to aggressive and polluting agents (e.g.: sulphide and ammonia gases, salty fog, fumes) to prevent corrosion and/or oxidation;
5. High-levels of magnetic and/or radio-frequency interference (avoid installing the instrument near transmitting antennae);
6. Exposure to direct sunlight and atmospheric agents in general.

When connecting the control follow these INSTRUCTIONS carefully:

1. Incorrect connection of the power supply may seriously damage the system.
2. Use cable ends suitable for the terminals. Loosen each of the screws and insert the cable end, then tighten the screws. On completing this operation lightly tug the cables to check they are solidly inserted. **Do not use automatic screw drivers to tighten the screws; if necessary, tighten them with a torque less than 50 N cm.**
3. Separate as much as possible (at least 3 cm), the probe signal cables, the 0÷10 V output cables and the digital input cables, from the inductive load and power cables, in order to avoid electromagnetic interference;
4. Never place power cables, probe cables, 0÷10 V output cables and digital input cables in the same cable channel (including the electrical panel channel).
5. Make sure that probe cables, 0÷10 V output cables and digital input cables are not installed in the immediate vicinity of the power devices (contactors, thermo-magnetic switches, etc.).
6. Use the shortest possible route for the probe cables and make sure that they do not surround the power devices.
7. Please remember that thermistor temperature probes (NTC) do not have polarity, and so the ends can be connected in any order.
8. The probes can be positioned up to a maximum of 100 m from the control. To extend the length of the cables use cables with a minimum cross-section of 1mm², shielded if possible. In this case the shield should be connected to the GND of the probe inputs; do not earth or connect the other end (that is the sensor end) of the shield to other references.
9. Avoid powering the control from the general panel power supply if other devices such as contactors, solenoid valves, etc. are also connected.

5 Functions

The output of the FCM* controller provides a continuous voltage signal ranging between 0 V and 10 V; the exact value depends on the measurement made by the connected probes, according to the selected operating mode and the programmed control parameters. Alternatively, the control output can be used to carry out On/Off regulation. The voltage signal is connected to an actuating device which regulates the system; as a consequence it keeps the controlled value within the set limits.

The types of probes which can be used depend on the model of control:

- **NTC-type probes** automatically range of measurement and connections are identified.
- **NTC probes and 4÷20mA current probes** → disconnection is automatically identified and the relative alarm generated.
- **probes with voltage or current output** → the type of value measured must be selected, that is (temperature/humidity or pressure), as well as the minimum and maximum measurable values.

In the specific case of **condensation temperature control based on the use of pressure probes**, it is possible to convert automatically the measurements into temperature, thus simplifying the condenser operating mode. To make automatic conversion possible, it is necessary to select the exact type of refrigerant to be used.

Note: If the refrigerant used is not R22, R404A, R407, R134A, R410A, R290 or NH₃ (ammonia), conversion will not be possible and all values will be expressed in bar.

5.1 Serial option

To make connection possible, a serial interface board for 2-lead RS-485 standard serial communication must be inserted inside the control.

This board (code FCSE0000) can be used both for connection to supervisory network and for pLAN network.

The parameters concerning serial connection (P52,...,P56) must be set according to the type of connection selected.

The board may also be ordered and installed at a later time.

To insert the board inside the control:

1. disconnect power supply;
2. lift the front panel by levering it with a suitably-sized screwdriver;
3. insert the board into the relative connector inside the control, making sure that the polarity key corresponds to the guide slot beside the connector;
4. replace the front panel to its original position.

FCSE0000 card mounting

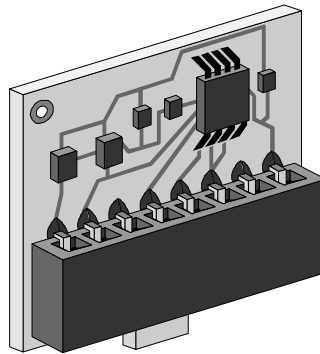

Fig.2

6 Programming and configuring the FCM*

6.1 Standard configuration

The FCM controls are supplied with the following default settings:

FCM00NTC00:

- NTC probes (range: $-40^{\circ}\text{C} \div 100^{\circ}\text{C}$);
- display in degrees $^{\circ}\text{C}$.

FCM0001000:

- temperature probes with $0 \div 10$ V voltage output;
- range: $-40^{\circ}\text{C} \div 100^{\circ}\text{C}$;
- display in degrees $^{\circ}\text{C}$.

FCM0002000:

- pressure probes with $4 \div 20$ mA current output;
- range: $0 \div 30$ bar;
- unspecified refrigerant;
- display in bar.

The following configuration is valid for all models:

- "DIRECT" operating mode;
- use of probe 1 only;
- probe input 'filter' with time constant=1 second;
- set-point with min. value;
- operating range of the output $0 \div 10$ V: from 0% to 100%;
- soft-start at 2 seconds;
- cut-off at 0;
- speed-up disabled;
- combined action disabled;
- High and Low alarms disabled;
- digital inputs not used;
- digital output not used;
- display of the unit of measure;
- normally displayed value: measurement of probe 1;
- keypad and remote control enabled.

6.2 Initialisation of FCM* instruments

When programming the FCM* controller, follow these instructions carefully:

- first select the **operating mode** (parameter C00), as some parameters are normally hidden and are only accessible in particular operating modes;
- select the **type of probe** used (if different from the default type) (C13 parameter), the **type of refrigerant** used (if necessary, param. C14), and the **minimum and maximum values** of the probes (parameters C15 and C16);
- configure inputs and outputs (parameters C19, C29, C30, C31);
- set the remaining C parameters (configuration parameters);
- set the P parameters (frequently-used parameters);
- set the set-point.

OPERATING MODE. The operating mode is set by **parameter C00**.

C00=0 → slave-direct operation. In SLAVE-DIRECT operation, the $0 \div 10$ V output of the control is directly proportional to the value of probe 1. the minimum value of the probe (0V or 0mA or 4mA) corresponds to the minimum value of the output (param. C04); the maximum value of the probe (10V or 20mA) corresponds to the maximum value of the output (param. C05).

In this operating mode not all parameters will be available. *This operating mode is not available in model FCM00NTC00.*

C00=1 → slave-reverse operation. In SLAVE-REVERSE operation, the $0 \div 10$ V output of the control is inversely proportional to the value of probe 1. The minimum value of the probe (0V or 0mA or 4mA) corresponds to the maximum value of the output (param. C05); the maximum value of the probe (10V or 20mA) corresponds to the minimum value of the output (param. C04).

In this operating mode not all parameters will be available. *This operating mode is not available in model FCM00NTC00.*

C00=2 → DIRECT operation. In DIRECT operation, the $0 \div 10$ V output of the controller increases as the values measured by the probes increase, depending on the set-point (param. St1) and on the other control parameters.

C00=3 → REVERSE operation. In REVERSE operation, the $0 \div 10$ V output decreases as the values measured by the probes increase, depending on the set-point (param. St1) and on the other control parameters.

C00=4 → DIRECT/REVERSE mode through digital input. This operating mode depends on the status of the digital input ID1:

ID1 not active (open) → DIRECT operation with main set-point and differential (St1 and P01);

ID1 active (closed) → REVERSE operation with main set-point and differential (St1 and P01);.

C00=5 → DIRECT(SET1) /DIRECT(SET2) mode through digital input

This operating mode depends on the status of the digital input ID1:

- ID1 not active (open) → DIRECT operation with main set-point and differential (param. St1 and P01);
- ID1 active (closed) → DIRECT operation with secondary set-point and differential (param. St2 and P02)

C00=6 → REVERSE(SET1)/REVERSE(SET2) mode through digital input

This operating mode depends on the status of the digital input ID1:

- ID1 not active (open) → REVERSE operation with main set-point and differential (param. St1 and P01);
- ID1 active (closed) → REVERSE operation with secondary set-point and differential (param. St2 and P02);

C00=7 → DIRECT(SET1) /REVERSE(SET2) mode through digital input (cooling/heating operation)

This operating mode depends on the status of the digital input ID1:

- ID1 not active (open) → DIRECT operation with main set-point and differential (param. St1 and P01);
- ID1 active (closed) → REVERSE operation with secondary set-point and differential (param. St2 and P02);

C00=8 → DIRECT(SET1) /REVERSE(SET2) operation +Defrost through digital input

(cooling/heating operation mode with Defrost)

This operating mode depends on the status of the digital input ID1:

- ID1 not active (open) → DIRECT operation with main set-point and differential (param. St1 and P01);
- ID1 active (closed) → REVERSE operation with secondary set-point and differential (param. St2 and P02) and Defrost cycle management (param. P40, P41, P42, P43, P44 and P45). The relay output is utilised to manage the four-way valve for inverted freezing circuit.

6.3 Auxiliary functions

In order to optimise the performance of the controller, there are extra functions available:

Measurement 'filtering'. A 'filter' with programmable time constant (see parameter C17), can be applied to the measurements detected by the probes in order to eliminate any disturbance or slow down the response of the system.

Min/Max. Allows the operating field of the 0÷10 V output to be limited within a maximum (parameter C05) and a minimum value (parameter C04), programmable in %.

Soft-start. Allows you to limit the variation speed of the 0÷10 V output so as to avoid excessive stress on the actuator or stabilise the system (parameter C06).

Cut-off (not available in SLAVE mode). If the minimum value of the 0÷10 V output is set to a value different than zero, this function allows the output to be cut-off if the measurement exceeds the set limit (parameter C07). There is a hysteresis in order to avoid hunting problems.

Speed-up (not available in SLAVE mode). Forces the 0÷10 V output to the maximum set level, for a set time (parameter C08) when, starting from output-disabled status, a value different than zero is selected. This function may be used to overcome system inertia and, in case of fan-speed control, it ensures rotation even at slow speed (which is normally difficult when the fans are off).

Type of set-point (not available in slave mode). Defines the position of the set-point within the control band (or differential) (parameter C03)

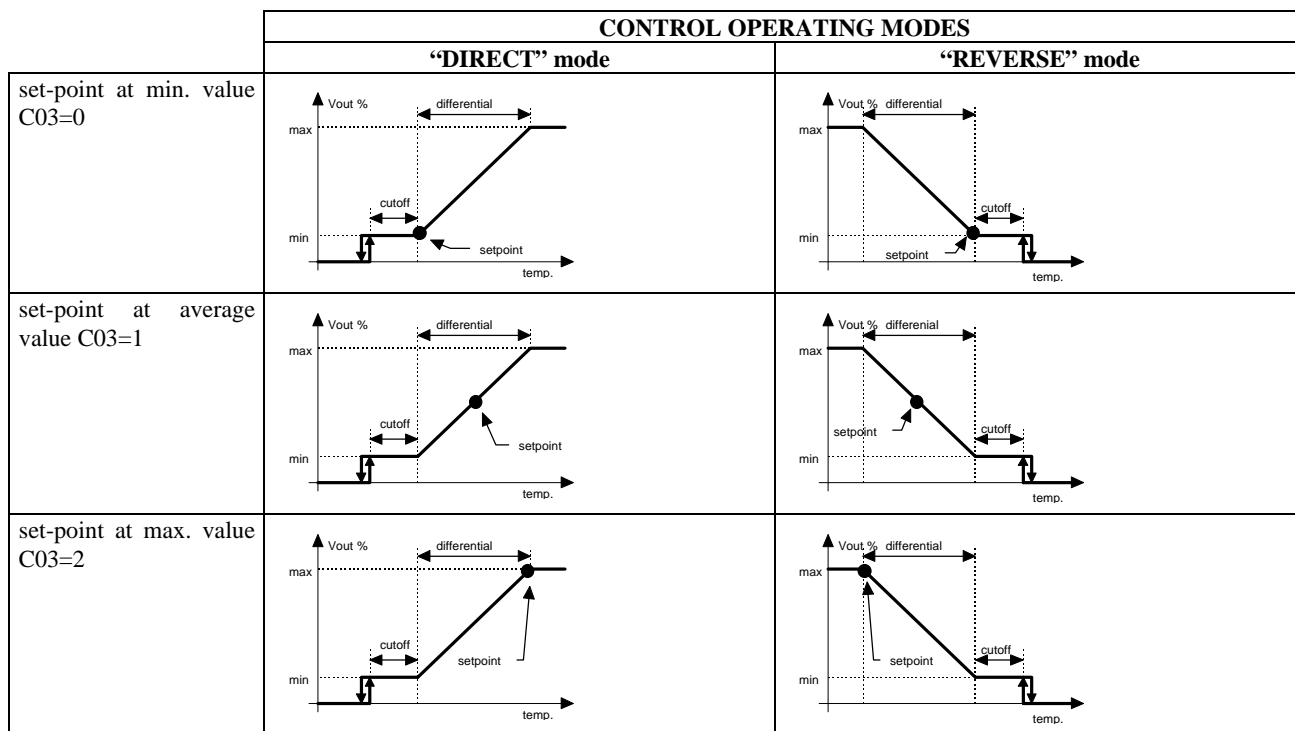

Fig.3

• **Integral control action (not available in SLAVE mode)**

The control action, normally proportional, can be modified to PI (proportional and integral) with programmable integral action (parameter C09). In this case, the control acts so as to maintain the measured value within the control band, independently of the type of set-point selected.

- **Second probe management** (not available in slave mode)

The value of the measurement actually used by the controller depends on the two probe inputs, and can be selected (parameter C19) keeping into consideration the following elements:

- probe 1 (probe 2 not used);
- greater value of the two probes (lower in reverse operation);
- lower value of the two probes (greater in reverse operation);
- difference between the two probes (probe1 - probe2);
- probe 1 for control, probe 2 for defrost control.

- **Detection of disconnected probe**

When using NTC or 4÷20 mA probes, their disconnection is automatically detected. In this case, a message will be displayed, the control action will be interrupted and the 0÷10 V output will be disabled or forced to the set value (parameter C10). When the connection is restored, control is automatically resumed. The detection of disconnected probes concerns exclusively the probes being currently used.

6.4 High and Low alarms (not available in slave mode)

If the measured value remains below the Low threshold (parameter P25) or above the High threshold (parameter P26) for a minimum time defined by parameter P28, the dedicated alarm will be generated. A Low or High alarm condition results in the following signals:

- the buzzer sounds;
- a message appears on the display;
- energisation of the digital relay (if programmed);
- no effect on the control action.

Automatic disabling of the digital output can be programmed using parameter P27.

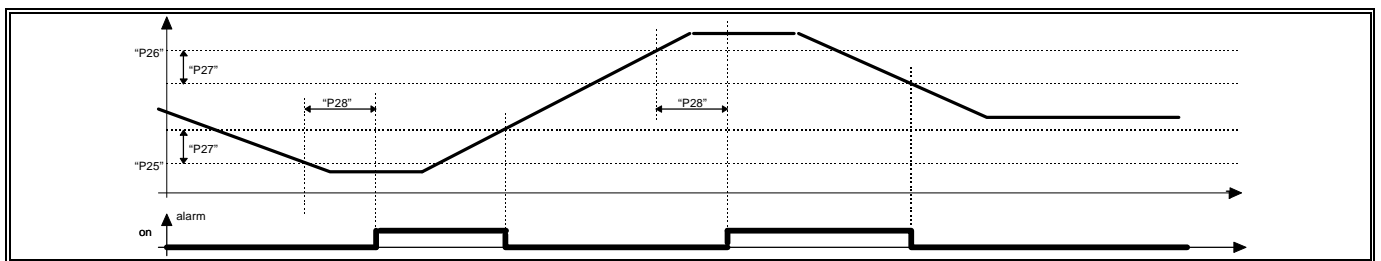

Fig.4

In the event of High alarm in “direct” mode or Low alarm in “reverse” mode:

the 0÷10 V output can be forced to its max. value (100%) irrespective of the maximum programmed value (parameter C10). The output remains at 100% for the entire duration of the alarm. It is recommended, in this case, to set a low value for the alarm differential (parameter P27), so that the alarm deactivates as soon as the controlled value returns within the alarm threshold.

6.5 Defrosting (not available in SLAVE mode)

When in **cooling/heating operating mode with Defrost management** (parameter C00=8), it is possible to set a **Defrost threshold** that starts a defrost cycle (parameter P40). **Below this threshold (with a delay defined by parameter P42):**

- defrost starts;
- the relay output is commuted;
- control action interrupts;
- the 0÷10 V output is forced to the value fixed by parameter P45.

The Defrost procedure may last until the set **Defrost threshold which makes the cycle end** (parameter P41) has been exceeded:

1. if you set the max. allowable time (defined by parameter P43) → on exceeding the maximum time an alarm signal is generated. The frequency of defrost cycles can be limited, by setting a minimum time between consecutive defrost cycles (parameter P44);
2. if you want to set a fixed time (parameter P43) → the threshold ending the defrost cycle must be set to its maximum value.

Defrost control:

- uses the same probes as those used for normal control functions, or
- uses probe 2 for Defrost control and probe 1 for normal control action.

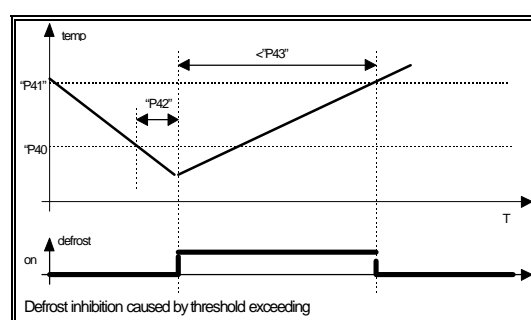
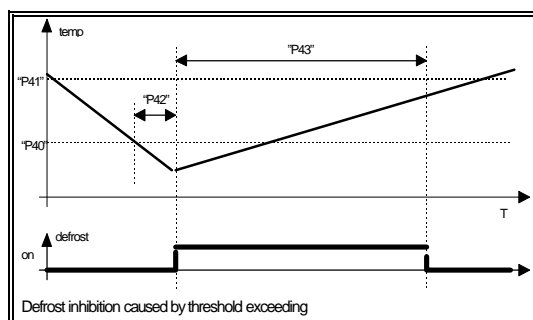

Fig.5

6.6 Multifunction digital inputs

The terminal block comes complete with two digital inputs which can be associated with two commands, whose function can be selected by using parameters **C29** and **C30**.

- **automatically-reset alarm:** when the contact opens, the analogue output is immediately forced to 0 V and the corresponding alarm is generated. The alarm condition will persist until the contact closes.
- **manually-reset alarm:** when the contact opens, the analogue output will be immediately forced to 0 V and the corresponding alarm will be generated. The alarm condition must be reset manually, that is acting on the keypad, after the contact has closed again.
- **delayed alarm and manual reset:** the same as the manually-reset alarm. The alarm will be generated as soon as the previously set time-interval has passed (parameter P28).
- **enabling/disabling:** in the event of open contact, the analogue output is immediately forced to 0 V.
- **max. value of the 0÷10 V output:** in the event of closed contact, the analogue output is immediately forced to 10 V, independently of the max. value given to the parameter.

You should notice the following:

1. If you select an operating mode which involves a command coming from terminal block (C00 greater or equal to 4), the command automatically matches the ID1 input.
2. If both digital inputs are available and they are given the same function (alarm, enabling or output to 100%), ID1 has priority.

6.7 Multi-function digital output

The terminal block comes complete with a relay digital output which can be associated with one of the functions listed below. You can select the normally energized relay or the normally disenergized relay option (parameter C31). When you select the Cooling/Heating operation mode with defrost management (parameter C00=8), the relay is used to manage the defrost cycle, independently of the previously set programmed functions.

- **Alarm signal:** generates in the event of any off-normal condition.
- **Active 0-10V output signal:** generates when the voltage supplied to the 0÷10 V output is different than 0 V.
- **Signal of max. value of the output:** generates when the voltage supplied to the 0÷10 V output has reached its max. programmed value. It disappears when the hysteresis is 0.5 V. (The speed-up function does not affect this signal).
- **On/Off regulation:** starts when the voltage to the 0÷10 V output reaches its max. programmed value. It deactivates when the voltage to the 0÷10 V output reaches its min. programmed value. (The speed-up function does not affect this signal).

6.8 Extra LED indicators

The display shows:

- LED OUT ---> indicates the status of the 0÷10 V output of the controller
- LED AUX ---> its meaning depends on the selected operating mode

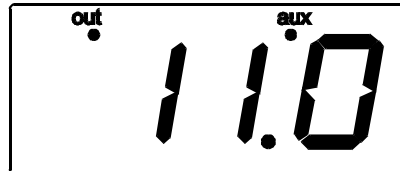

Fig. 6

Type	Status	Description	
OUT	off	0 V output	
	on	output energized	
	blinking	output at max. programmed voltage	
AUX	C00=0,1,2,3	off	relay digital output disenergized
		on	relay digital output energized
	C00=4,5,6,7	off	input ID1 open (matched function not active)
		on	input ID1 closed (matched function active)
	C00=8	off	input ID1 open (cooling mode)
		on	input ID1 closed (heating mode)
blinking		input ID1 closed (heating mode) and defrost commad active	

Tab. 1

7 Programming FCM controllers

There are three groups of parameters which allow you to customize the use of the FCM instrument, according to your specific application requirements:





"C" Parameters or configuration parameters: are to be set at the very beginning, depending on the features of your FCM, its inputs and outputs.

"P" Parameters or frequently-used parameters: can be frequently modified in order to optimize the performance of the controller according to changed operating conditions.

Set-point Parameters: can be easily accessed by the end-user without any technical support; they allow you to change the value of the parameters to be controlled.

At **start-up**, after the initial waiting step displayed by "---", and during the normal operating mode, the value given to "C33" will be displayed. (The symbol "---" will appear in the event of current disabling command coming from terminal block).

Main functions of the buttons:









-  : press it to display the unit of measure of the parameter actually being displayed for 1 second .
-  : press it to display the value of the 1st probe; this value is preceded by the corresponding unit of measure, displayed for 1 second (even if the probe is disconnected).
-  : press it to display the value of the 2nd probe; this value is preceded by the corresponding unit of measure, displayed for 1 second (even if the probe is disconnected).
- When an alarm condition occurs, pressing  once will silence the buzzer; if you press it a second time, the alarm signal is cancelled (provided that the cause that generated the alarm has been removed).

The programming procedure includes three levels of accessibility to the parameters:









- display and modification of set-point parameters ONLY;
- display and modification of "P" (frequently-used) parameters, set-points included;
- display and modification of all parameters: set-point, "P" and "C" parameters.

Note: it is not possible to move from one level to another straightforwardly. To do so you must first bring the current programming procedure to an end, then enter another programming level













7.1 Setting the set-point ("St" parameters)

1. hold down  (for about 2 seconds) until "St1" appears on the display;
2. when SEL is released, the unit of measure of the set-point is displayed for 1 second; after that the display shows the current value of the set-point;
3. press  or  to change its value (hold down the buttons to quickly increase or decrease the value);
4. press  to confirm the displayed value. If there isn't a second set-point, the programming procedure is over, otherwise "St2" will be displayed.
5. when  is released, the unit of measure of the set-point is displayed for 1 second; after that the display shows the current value of the set-point;
6. press  or  to change its value (hold down the buttons to quickly increase or decrease the value);
7. press  or  to confirm the displayed value and exit the programming procedure.

7.2 Accessing "P" parameters

1. hold down  (for about 5 seconds) until "P01" appears;
2. press  or  to scroll all "P" parameters, set-points included (hold down the buttons to gradually increase the scrolling speed);
3. press  to display the value of the selected parameter (the corresponding unit of measure will be displayed first for 1 second);
4. press  or  to change the value of the parameter (hold down the buttons to quickly increase or decrease the value);
5. press  to confirm the displayed value. The identification code of the parameter will appear again on the display.
Note: to display and modify, if necessary, other parameters, repeat steps 2, 3, 4, 5 above.
6. press  to save any modification and exit the programming procedure.

7.3 Accessing "C" parameters

1. hold down  and  together for about 5 seconds, until "00" appears on the display; after that digit the **password**;
2. press  and  to introduce the **password** ("77");
3. press  to confirm the password. If the password is incorrect, the programming procedure will interrupt, otherwise "C00" will be displayed.
4. press  and  to scroll the list of the parameters (hold the buttons down to scroll the parameters quickly);
5. press  to display the value of the selected parameter (the corresponding unit of measure will be displayed first for 1 second);
6. press  and  to change the value of the parameter (hold down the buttons to quickly increase or decrease the value);
7. press  to confirm the displayed value. The identification code of the parameter will appear again on the display;
Note: to display and modify, if necessary, other parameters, repeat steps 4, 5, 6, 7 above.
8. press  to save any modification and exit the programming procedure.

7.4 Validity of the modifications

Any modification will become operative as soon as it is confirmed by pressing . The following parameters, instead, will become operative immediately: **St1, St2, P01, P02, C04, C05, P25, P26, P27, P40, P41, P45**. **Some parameters, especially those related to serial connection, will become operative only after you have re-started the instrument.**

After 5 seconds from the release of the last button during the programming phase, the display starts to flash (this means you are still operating in the programming section). After 60 seconds from the release of the last button, during which the display shows the value of a parameter, the previous modification will be neglected and the display will show the identification code of that parameter. After further 5 seconds, the display will start to flash again and after 60 seconds the programming procedure will automatically exit; the values of the parameters will remain the same as the ones set before the programming phase.

If you are displaying the identification code of a parameter, the programming procedure will automatically exit after 60 seconds.

Display	Unit of measure
°C	temperature in degrees Centigrade
°F	temperature in degrees Fahrenheit
rH	relative humidity in %
bAr	pressure in bar
SEc	time in second (or milliseconds)
Min	time in minutes
%	percent
h	hexadecimal number

7.5 Displaying the unit of measure











Displaying the unit of measure is extremely useful as it avoids any misunderstanding of the values of each single parameter. The unit of measure depends on the type of probe being used as well as on the configuration of the instrument. It is always possible, however, not to make the unit of measure appear on the display, or make it appear only when you have to access parameters P and C (parameter C32). In the event of an adimensional number, the unit of measure will not be displayed.

7.6 Setting min. and max. output values

In order to set-up the controller in the easiest way, you can avail yourself of a special procedure allowing you to set the minimum (parameter C04) and maximum (parameter C05) values of the 0÷10 V output of the FCM controller. This function helps optimize the performance of the connected fans.

Note: using this procedure means to energize the analogue output, that is, to actuate the rotation of the connected fans, independently of the previously set operating mode and of any command coming from terminal block

To set the min. and max. output values follow the instructions below (at start up only):



1. press  and  within 5 seconds from start-up until the display shows "C04";
2. press : the output energizes until it reaches the current value of the C04 parameter; its value will be displayed in percentage (the variation speed of the output is 5% per second, that is 0.5 V/s). Press  or  to interrupt the output variation before it reaches the C04 value;
3. use  and  to set the new value (hold the button down to increase/decrease the value of the parameter quickly);
4. press  to confirm the new value. "C04" will appear on the display; the output will gradually go to zero;
5. press  and  to display "C05";
6. to set the max. output value, follow the same indications as for the minimum value (using C05 instead of C04)

Note: the instructions above can be repeated as many times as you wish, according to your application requirements

7. press  to store the new values (C04 and C05) and return to normal operation.

7.7 Factory-set parameters

Re-setting factory-set values can be done only at start-up, as follows:

1. hold  down for about 5 seconds within 5 seconds from start-up until "--" is displayed (the dash on the top flashes);
2. release  within 3 seconds so as to re-set and store the factory-set values. The symbol "--", which appears for 2 seconds, shows that the procedure has been correctly carried out and the factory-set data have been stored.

If you do not release  within 3 seconds, the parameters will NOT be modified (the symbol "--" will then be displayed).

7.8 Remote Control

In order to make the programming procedure of the FMC easier, Carel suggests using the remote control, not only to program data from a remote position but also to set the most common and most used parameters quickly and easily. **The remote control allows you to display and modify set-points and all P and C parameters from a distant point.** In addition, the availability of several buttons allows you to access the main parameters directly. The FCM* series features the possibility of setting on each single instrument an access code (parameter C51) which simplifies the use of the remote control. If, for example, your panel comprises several controllers, you can modify the parameters of only one of them, just by digiting the code of the FCM controller whose data you wish to change.

Using the remote control is therefore time-saving and safe: any modification, in fact, requires you to press the ENABLE button to begin the procedure (this avoids any involuntary modification of the parameters). In addition, C50 prevents any unauthorized use of the remote control: depending on its value, C50 inhibits any modification or allows you to access and modify only P parameters.

7.9 Technical specifications

Power Supply	2 alkaline batteries, 1.5V (type UM-4 AAA, IEC R03)
Case	plastic
Dimensions	60x160x18mm
Storage temperature	-25°C÷70°C
Operating temperature	0°C÷50°C
Transmission type	Infrared
Weight	80g (without batteries)

7.10 Description of the keypad

The buttons on the keypad can be divided into three groups, depending on their specific functions:

- buttons which enable/disable the use of the remote control;
- pre-programmed buttons to modify the main parameters;
- buttons for the remote control of the keypad of the FMC instrument.

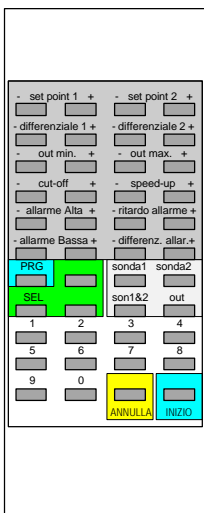

Buttons which enable/disable the use of the remote control

These buttons allow you to enable the use of the remote control, to disable it and to give the parameters new values, storing them (if necessary).

ENABLE	enables the use of the remote control
PRG	exits the programming stage and saves the new values
ESC	exits the programming stage and annuls any modification
numeric keypad	allows you to set the parameters' access code; we recommend using the code especially when several devices are under the beam of the infrared remote control, as in electrical panel including many controllers. Setting a different code for each single instrument allows you to modify the parameters of only one specific controller.

Buttons which modify the main parameters (direct access buttons)

The most commonly used parameters are indicated on the remote control where you can see three different areas on a light grey background:

- parameters related to set-points;
- display of any measurement (P parameters: reading only parameters);
- parameters related to the main regulation functions.

Buttons for the remote control of the keypad of the FMC instrument

The green section on the remote control reproduces the keypad of the FCM; this section allows you to perform the same operations as if you were acting on the FCM keypad. This part includes the following buttons:

- PRG** • saves any value and exits the programming procedure;
- SEL** • displays the unit of measure and the value of the selected parameter;
- confirms the modified value and shows the identification code of the parameter;
- ▲** • 1) goes from one parameter to the next one;
- 2) increases the value of the displayed parameter (while setting the parameter values)

- ▼
 - 1) goes from one parameter to the previous one;
 - 2) decreases the value of the displayed parameter (while setting the parameter values)

7.11 Using the remote control

Access without code

- 1) **ENABLING THE FCM CONTROLLER TO RECEIVE INSTRUCTIONS FROM THE REMOTE CONTROL**
 - Be sure not to be in the programming section; then press ENABLE to enable the use of the remote control;
 - the identification code of the first accessible parameter appears on the display. If the display shows two digits, an enabling code must be introduced (in this case see "Access with code" below).
- 2) **MODIFICATION OF THE MAIN PARAMETERS**
 - press - or + until you reach the parameter whose value you want to change. After that the instrument displays the **code** of the selected parameter (see codes at the end of this user manual or on the instruction sheet of your FCM instrument); when you press these buttons a second time, the display will show the value given to that parameter;
 - press + to increase its value;
 - press - to decrease its value;
 - to display one of the factory-set values, press the relevant button twice.

Note: when out of the programming phase, **SEL** (displaying the unit of measure), **PRG** (concerning alarm reset functions) and the buttons allowing you to display directly the parameters are always enabled. You don't need to press ENABLE or insert the access code.

- 3) **MODIFICATION OF THOSE PARAMETERS LACKING A DEDICATED BUTTON**

The parameters which do not have a dedicated button can be modified as follows:

 - carry out instructions as described in 1) above;
 - press ▲ or ▼ until the display shows the desired parameter;
 - press SEL to display the value given to the selected parameter;
 - press ▲ or ▼ to increase or decrease its value;
 - press SEL to confirm the new value and return to the main mask showing the identification code of the parameter;
 - to modify another parameter repeat the procedure.
- 4) **HOW TO EXIT THE PROGRAMMING PROCEDURE**
 - press PRG to exit and save any modification;
 - press ESC to exit without saving any modification;
 - do not press any key for 60 seconds if the identification code of the parameter is being displayed or for 120 seconds if the display shows the value of the parameter: in both cases the controller automatically exits the programming procedure without saving any modification.

Access with code

- 5) **ENABLING THE FCM CONTROLLER TO RECEIVE INSTRUCTIONS FROM THE REMOTE CONTROL**
 - Be sure not to be in the programming section; then press ENABLE to enable the use of the remote control;
 - all devices under the influence of the remote control's beam show their identification code;
 - insert the code of the controller whose parameters needs to be modified (use the numeric section on the keypad of the remote control). Insert the right code adding zeroes if they are part of the code (IE: 05);
 - if the code has been correctly inserted, the display will show the first accessible parameter;
 - go on following points 2), 3), or 4) described above.

7.12 Setting the access code

The factory-set program automatically deactivates the access code. To activate it, modify parameter C51, giving it a value different from 0. To deactivate the code you have to give the value equal to 0 to parameter C51. In this way it is possible to use the remote control without the access code.

8 Description of the parameters

8.1 Parameters concerning the set-point

St1: Set-point 1 (main)

St1 is the most important parameter; it is used in any operating mode, except in SLAVE.

Access:

<u>Keypad:</u>	if C50=1, 3 or 4 → direct access pressing  ;
	if C50=0 or 2 → the parameter can only be displayed.
<u>Remote Control:</u>	if C50=0, 1 or 4 → direct access pressing "ENABLE" and, after that, the dedicated buttons;
	if C50=2 or 3 → the parameter can only be displayed.
<u>Modes:</u>	in any operating modes except C00=0 and 1 ("SLAVE DIRECT" and "SLAVE REVERSE" modes)
<u>Operating range:</u>	from -40°C (-40°F) to 100°C (212°F) for temperature from 0.0 to 100 bar or rH for pressure and humidity

Default: St1=0.0.

St2: Set-point 2 (secondary)

St2 can be used alternatively to St1 in those operating modes based on the presence of St2.

Access:

<u>Keypad:</u>	if C50=1, 3 or 4 → direct access pressing  ;
	if C50=0 or 2 → the parameter can only be displayed
<u>Remote Control:</u>	if C50=0, 1 or 4 → direct access pressing "ENABLE" and, after that, the dedicated buttons:
	if C50=2 or 3 → the parameter can only be displayed.
<u>Modes:</u>	in modes based on the presence of two different set-points, C00=5, 6, 7 and 8
<u>Other parameters:</u>	does not depend on other parameters.
<u>Operating range:</u>	from -40°C (-40°F) to 100°C (212°F) for temperature from 0.0 to 100 bar or rH for pressure or humidity



Default:

St2=0.0.

C00: Operating mode

C00 is the most important configuration parameter. It defines the operating mode of the controller (see the description of the operating modes above).

Access:

<u>Keypad:</u>	if C50=1, 3 or 4 →  +  for 5" and password 77;
	if C50=0 or 2 → the parameter can only be displayed.
<u>Remote Control:</u>	if C50=4 → press "ENABLE" and ▲ and ▼;
<u>Modes:</u>	available in all modes except C00=0 and 1 ('SLAVE DIRECT' and 'SLAVE REVERSE' modes)
<u>Operating range:</u>	from 0 to 8
C00=0 →	SLAVE DIRECT
C00=1 →	SLAVE REVERSE
C00=2 →	DIRECT
C00=3 →	REVERSE
C00=4 →	DIRECT & REVERSE (input ID1)
C00=5 →	DIRECT-St1 & DIRECT-St2 (input ID1)
C00=6 →	REVERSE-St1 & REVERSE -St2 (input ID1)
C00=7 →	DIRECT -St1 & REVERSE -St2 (input ID1)
C00=8 →	DIRECT -St1 & REVERSE -St2-Defrost (Defrost) (input ID1)
<u>Default:</u>	C00 = 2 → DIRECT. .

P01: Differential of St1

P01 defines the hysteresis of St1 (that is the width of the regulation zone). It is a relative value which can have the same value as St1 or can be set on its right or on its left.

Access:

<u>Keypad:</u>	if C50=1 or 3 → press  for 5";
	if C50=0, 2 or 4 → the parameter can only be displayed.
<u>Remote control:</u>	if C50=0, 1 or 4 → direct access pressing "ENABLE" and, after that, the dedicated buttons
	if C50= 2 or 3 → the parameter can only be displayed.
<u>Modes:</u>	in all modes except C00=0 and 1 ("SLAVE DIRECT" and "SLAVE REVERSE")
<u>Operating range:</u>	from 0.0 to 100 (180°F).
<u>Default:</u>	P01 = 2.0 (3.6°F).

Note: the type of set-point depends on C03.

P02: Differential of St2

P02 defines the hysteresis of St2 (that is the width of the regulation zone). It is a relative value which can have the same value as St2 or can be set on its right or on its left.



Access:

<i>Keypad:</i>	if C50=1 or 3	→	press  for 5”;
	if C50=0, 2 or 4	→	the parameter can only be displayed.
<i>Remote control:</i>	if C50=0, 1 or 4	→	direct access pressing “ENABLE” and, after that, the dedicated buttons;
	if C50= 2 or 3	→	the parameter can only be displayed.
<i>Modes:</i>	in modes based on the presence of two different set-points, C00=5, 6, 7 and 8		
<i>Other parameters:</i>	does not depend on other parameters.		
<u>Operating range:</u>	from 0.0 to 100 (180°F).		
<u>Default:</u>	P02 = 2.0 (3.6°F).		
Note:	the type of set-point depends on C03.		

C03: Type of set-point

C03 indicates if the set-point corresponds to the min., max. or average value of the analogue output.

Access:



<i>Keypad:</i>	if C50=1, 3 or 4	→	press  +  for 5” and password 77;
	if C50=0 or 2	→	the parameter can only be displayed.
<i>Remote control:</i>	if C50=4	→	press “ENABLE” and ▲ and ▼;
<i>Modes:</i>	in all modes except C00=0 and 1 (“SLAVE DIRECT” and “SLAVE REVERSE”)		
<i>Other parameters:</i>	does not depend on other parameters.		
<u>Operating range:</u>	from 0 to 2		
C03=0	→	set-point corresponds to the min. output value	
C03=1	→	set-point corresponds to the average output value	
C03=2	→	set-point corresponds to the max. output value	
<u>Default:</u>	C03=0 → set-point corresponding to the min. output value.		

8.2 Parameters concerning the analogue output

C04: Minimum output value

C04 defines the min. value of the 0÷10 V analogue output, expressed in %.



Access:

<i>Keypad:</i>	if C50=1, 3 or 4	→	 +  for 5” and password 77
	if C50=0 or 2	→	the parameter can only be displayed.
<i>Remote control:</i>	if C50=4	→	direct access pressing “ENABLE” and, after that, the dedicated buttons.
<i>Other parameters:</i>	does not depend on other parameters.		
<u>Operating range:</u>	from 0% to C05 (max. output value).		
<u>Default:</u>	C04 = 0%.		

C05: Maximum output value

C05 defines the maximum value of the analogue output in %.



Access:

<i>Keypad:</i>	if C50=1, 3 or 4	→	 +  for 5” and password 77;
	if C50=0 or 2	→	the parameter can only be displayed.
<i>Remote control:</i>	if C50=4	→	direct access pressing “ENABLE” and, after that, the dedicated buttons
<i>Other parameters:</i>	does not depend on other parameters.		
<u>Operating range:</u>	from C04 (min. output value) to 100%.		
<u>Default:</u>	C05 = 100% .		

C06: Soft-start

C06 defines the max. variation speed necessary to change the value of the analogue output, that is the time interval necessary to pass from 0 to 100% and vice-versa.

Access:



<i>Keypad:</i>	if C50=1, 3 or 4	→	 +  for 5” and password 77;
	if C50=0 or 2	→	the parameter can only be displayed.
<i>Remote control:</i>	if C50=4	→	press “ENABLE” and ▲ and ▼;
<i>Other parameters:</i>	does not depend on other parameters.		
<u>Operating range:</u>	from 0 to 120 seconds.		
<u>Default:</u>	C06 = 2 s. .		

Note: setting too long time-intervals may cause hunting problems.

C07: Cut-off

C07 defines the threshold beyond which the analogue output disenergizes (0 V). It is expressed as a relative value and refers to the minimum output value.

Access:



<i>Keypad:</i>	if C50=1, 3 or 4	→	 + 	for 5" and password 77;
	if C50=0 or 2	→		the parameter can only be displayed.
<i>Remote control:</i>	if C50=4	→		direct access pressing "ENABLE" and, after that, the
dedicated buttons.				
<i>Modes:</i>				in all modes except C00=0 and 1 ("SLAVE DIRECT" and "SLAVE REVERSE")
<i>Other parameters:</i>				does not depend on other parameters.
<u>Operating range:</u>				from 0.0 to 100 (180°F).
<u>Default:</u>				C07 = 0.0.

Note: if you do not want to use the cut-off function, set a very high value. The cut-off threshold has a hysteresis of 0.3 (0.6°F).

C08: Speed-up

C08 defines the duration of the speed-up function, that is the time-interval during which the analogue output is forced to its maximum programmed value (if energized).

Access:



<i>Keypad:</i>	if C50=1, 3 or 4	→	 + 	for 5" and password 77;
	if C50=0 or 2	→		the parameter can only be displayed.
<i>Remote control:</i>	if C50=4	→		direct access pressing "ENABLE" and, after that, the dedicated buttons.
<i>Modes:</i>				in all modes except C00=0 and 1 ("SLAVE DIRECT" and "SLAVE REVERSE")
<i>Other parameters:</i>				does not depend on other parameters.
<u>Operating range:</u>				from 0 to 120 seconds.
<u>Default:</u>				C08 = 0 s.

Note: in order not to use the speed-up function, set C08=0. Duration includes also the soft-start function.

C09: Integral action

C09 enables the PI regulation mode and defines its time-interval. With this regulation mode the running analogue output keeps the regulated value exactly at the set point.

Access:



<i>Keypad:</i>	if C50=1, 3 or 4	→	 + 	for 5" and password 77;
	if C50=0 or 2	→		the parameter can only be displayed.
<i>Remote control:</i>	if C50=4	→		press "ENABLE" and ▲ and ▼;
<i>Modes:</i>				in all modes except C00=0 and 1 ("SLAVE DIRECT" and "SLAVE REVERSE")
<i>Other parameters:</i>				does not depend on other parameters.
<u>Operating range:</u>				from 0 to 999 seconds.
<u>Default:</u>				C09 = 0 s.

Note: the integral action is much more intense if the time interval is short. To disable the PI regulation set C09=0. When working in the PI regulation mode, we suggest setting the set-point C03=1 (average value). In fact, the actual set-point corresponds to the central value of the regulation zone, independently of the selected set-point

C10: Value of the output in the event of disconnected probe or high alarm

C10 defines the value of the analogue output in the event of disconnected probe or active high (temperature, pressure, humidity) alarm (or low alarm in the reverse mode).

Access:



<i>Keypad:</i>	if C50=1, 3 or 4	→	press  + 	for 5" and password 77;
	if C50=0 or 2	→		the parameter can only be displayed.
<i>Remote control:</i>	if C50=4	→		press "ENABLE" and ▲ and ▼;
<i>Other parameters:</i>				does not depend on other parameters.
<u>Operating range:</u>				from 0 to 5
C10=0	→			disconnected probe: disenergized output (0%) High(Low) alarm: normal output
C10=1	→			disconnected probe: output=C04 (min. value) High(low) alarm: normal output
C10=2	→			disconnected probe: output=C05 (max. value) High(Low) alarm: normal output
C10=3	→			disconnected probe: disenergized output (0%) High(Low) alarm: 100% output
C10=4	→			disconnected probe: output=C04 (min. value) High(Low) alarm: 100% output
C10=5	→			disconnected probe: output=C05 (max. value) High(Low) alarm: 100% output
<u>Default:</u>				C10=0 → disconnected probe: disenergized output; High alarm: normal output.

8.3 Parameters concerning inputs

C13: Type of probes

C13 defines the type of electrical signal and the type of value measured by the probes.

Access:



<i>Keypad:</i>	if C50=1, 3 or 4	→	 +  for 5" and password 77;
	if C50=0 or 2	→	the parameter can only be displayed.
<i>Remote control:</i>	if C50=4	→	press "ENABLE" and ▲ and ▼;
<u>Operating range:</u>	0 for FCM00NTC00, 1 to 2 for FCM0001000, 3 to 7 for FCM0002000.		
C13=0	→	NTC probes (10 kΩ at 25°C)	
C13=1	→	0÷10 V probes for temperature or humidity	
C13=2	→	0÷10 V probes for pressure	
C13=3	→	0÷20 mA probes for temperature or humidity	
C13=4	→	0÷20 mA probes for pressure	
C13=5	→	4÷20 mA probes for temperature or humidity	
C13=6	→	4÷20 mA probes for pressure	
C13=7	→	CAREL 4÷20 mA probes for temperature or humidity	
<u>Default:</u>	C13 = 0 for FCM00NTC00, 1 for FCM0001000, 6 for FCM0002000.		

Note: CAREL 4÷20 mA probes are connected according to the figures on page XXX, since it is expected a 100Ω maximum load value resistance.

C14: Type of refrigerant

C14 defines the type of refrigerant. If your system includes pressure probes, the knowledge of the type of refrigerant allows you to convert pressure into temperature.

Access:

<i>Keypad:</i>	if C50=1, 3 or 4	→	 +  for 5" and password 77;
	if C50=0 or 2	→	the parameter can only be displayed.
<i>Remote control:</i>	if C50=4	→	press "ENABLE" and ▲ and ▼;
<i>Modes:</i>	in all modes except C00=0 and 1 ("SLAVE DIRECT" and "SLAVE REVERSE")		
<i>Other parameters:</i>	depends on C13=2, 4 and 6 (pressure probes).		
<u>Operating range:</u>	from 0 to 7		
C14=0	→	unspecified refrigerant	
C14=1	→	R22	
C14=2	→	R404a	
C14=3	→	R407	
C14=4	→	R134a	
C14=5	→	R410a	
C14=6	→	R290 (propane)	
C14=7	→	NH ₃ (ammonia)	
<u>Default:</u>	C14 = 0 unspecified refrigerant		



Not Available in FCM00NTC00.

Note: if the type of refrigerant is not specified, all the parameters concerning the measured variable will appear in bar. If the type of refrigerant is specified, the pressure reading will be automatically converted into temperature and displayed on the basis of the unit of measure as defined by C18.

C15: Minimum value of current or voltage inputs

C15 is the value measured when the input is given the min. possible signal, that is **0 V** when using 0÷10 V probes, **0mA** with 0÷20 mA probes or **4 mA** with 4÷20 mA probes.

Access:



<i>Keypad:</i>	if C50=1, 3 or 4	→	 +  for 5" and password 77;
	if C50=0 or 2	→	the parameter can only be displayed.
<i>Remote control:</i>	if C50=4	→	press "ENABLE" and ▲ and ▼;
<i>Modes:</i>	in all modes except C00=0 and ("SLAVE DIRECT" and "SLAVE REVERSE")		
<u>Operating range:</u>	from -40 to C16 for temperature probes in °C (C18=0) or °F (C18=1); from 0.0 to C16 for humidity probes in rH (C18=2) or pressure probes in bar.		
<u>Default:</u>	C15 = 0.0		

Not Available in FCM00NTC00.

C16: Maximum value of current or voltage inputs

C16 indicates the value measured when the input is given its maximum possible signal, that is **10 V** when using 0÷10 V probes, **20 mA** with 0÷20 mA and 4÷20 mA probes.

Access:

<i>Keypad:</i>	if C50=1, 3 or 4	→	 +  for 5" and password 77;
	if C50=0 or 2	→	the parameter can only be displayed.
<i>Remote control:</i>	if C50=4	→	press "ENABLE" and ▲ and ▼;
<i>Modes:</i>	in all modes except C00=0 and 1 ("SLAVE DIRECT" and "SLAVE REVERSE")		
<i>Operating range:</i>	from C15 to 100 for temperature probes in °C (C18=0); from C15 to 212 for temperature probes in °F (C18=1); from C15 to 100 for humidity probes in rH (C18=2) or pressure probes in bar.		

Default:

C16 = 100 for FCM00NTC00 and FCM0001000, 30.0 for FCM0002000.
Not Available in FCM00NTC00.



C17: 'Filter' on probe input

C17 measures the effect of the 'filter' on the controlled value. It is the time constant of the filter.

When setting low values there is a low 'filtering' effect, with a quick reading of any variation measured by the sensor.

When setting high values the responses of the sensor are transmitted more slowly; this ensures greater immunity against noises, hence steadier readings.



Access:

<i>Keypad:</i>	if C50=1, 3 or 4	→	 +  for 5" and password 77;
	if C50=0 or 2	→	the parameter can only be displayed.
<i>Remote control:</i>	if C50=4	→	press "ENABLE" and ▲ and ▼;
<i>Other parameters:</i>	not accessible when using pressure probes with unspecified refrigerant (C13=2, 4, 6 and C14=0).		
<i>Operating range:</i>	from 0.0 to 10.0 seconds.		
<i>Default:</i>	C17 = 1.0 s.		

C18: Unit of measure

C18 allows you to set the exact unit of measure for each parameter (St1, St2, P01, P02, C07, C15, C16, P40, P41, P25, P26, P27, P34, P35, P36). The unit of measure will appear in bar only when you use pressure probes with types of refrigerant different from those listed above (see C14).



Access:

<i>Keypad:</i>	if C50=1, 3 or 4	→	 +  for 5" and password 77;
	if C50=0 or 2	→	the parameter can only be displayed.
<i>Remote control:</i>	if C50=4	→	press "ENABLE" and ▲ and ▼;
<i>Modes:</i>	in all modes except C00=0 and 1 ("SLAVE DIRECT" and "SLAVE REVERSE")		
<i>Other parameters:</i>	not accessible when using pressure probes with unspecified refrigerant (C13 and C14).		
<i>Operating range:</i>	from 0 to 1 for FCM00NTC00 from 0 to 2 for FCM0001000 and FCM0002000.		
C18=0	→	°C (temperature in degrees Celsius)	
C18=1	→	°F (temperature in degrees Fahrenheit)	
C18=2	→	rH (relative humidity)	
<i>Default:</i>	C18 = 0 (°C).		

C19: Second probe

C19 indicates how to use the second probe.

Access:

<i>Keypad:</i>	if C50=1, 3 or 4	→	 +  for 5" and password 77;
	if C50=0 or 2	→	the parameter can only be displayed.
<i>Remote control:</i>	if C50=4	→	press "ENABLE" and ▲ and ▼;
<i>Modes:</i>	all modes except C00=0 and 1 ("SLAVE DIRECT" and "SLAVE REVERSE")		
<i>Operating range:</i>	from 0 to 4		
C19=0	→	second probe not used (disconnected input)	
C19=1	→	the actual measure is the greater of the two probes (the lower in the "REVERSE" mode)	
C19=2	→	the actual measure is the lower of the two probes (the greater in the "REVERSE" mode)	
C19=3	→	the actual measure is the difference between probe 1 and probe 2	
C19=4	→	the second probe is used exclusively for defrost control	
<i>Default:</i>	C19 = 0 → second probe not used.		

8.4 Alarm parameters

P25: Low threshold alarm

P25 identifies the threshold under which a Low (temperature, pressure, etc.) alarm is generated. P25 is an absolute value.

Access:

<u>Keypad:</u>	if C50=1, 3 or 4	→	press  for 5";
	if C50=0 or 2	→	the parameter can only be displayed.
<u>Remote control:</u>	if C50=0, 1 or 4	→	direct access pressing "ENABLE" and, after that, the dedicated buttons;
	if C50=2 or 3	→	the parameter can only be displayed..
<u>Modes:</u>	all modes except C00=0 and 1 ("SLAVE DIRECT" and "SLAVE REVERSE")		
<u>Operating range:</u>	from -40 to P26 for temperature probes or pressure probes with specified refrigerant, in °C (C18=0) or °F (C18=1); from 0.0 to P26 for humidity probes in rH (C18=2) or pressure probes with unspecified refrigerant in bar.		
<u>Default:</u>	P25 = -40 for FCM00NTC00 and FCM0001000 (threshold excluded) 0.0 for FCM0002000 (threshold excluded).		

Note: the alarm will be generated keeping into consideration the time-delay selected through the P28 parameter. Its automatic reset depends on the selected alarm differential P27. The alarm can be disabled giving P25 its minimum value

P26: High threshold alarm

P26 indicated the threshold beyond which the high (temperature, pressure, etc.) alarm is generated. It is an absolute value.

Access:

<u>Keypad:</u>	if C50=1, 3 or 4	→	press  for 5";
	if C50=0 or 2	→	the parameter can only be displayed.
<u>Remote control:</u>	if C50=0, 1 or 4	→	direct access pressing "ENABLE" and, after that, the dedicated buttons;
	if C50=2 or 3	→	the parameter can only be displayed.
<u>Modes:</u>	all modes except C00=0 and 1 ("SLAVE DIRECT" and "SLAVE REVERSE")		
<u>Operating range:</u>	from P25 to 100 for temperature probes or pressure probes with specified refrigerant in °C (C18=0); from P25 to 212 for temperature probes or pressure probes with specified refrigerant in °F (C18=1); from P25 to 100 for humidity probes in rH (C18=2) or pressure probes with unspecified refrigerant in bar.		
<u>Default:</u>	P26 = 100 (212°F) - threshold excluded.		

Note: the alarm will be generated keeping into consideration the time-delay selected through the P28 parameter. Its automatic reset depends on the alarm differential P27. The alarm can be disabled giving P26 its maximum value.

P27: Low/High Alarm Differential

P27 indicates the hysteresis between the value that generates a Low or High (temperature, pressure, etc.) alarm and the value which deactivates it.

Access:

<u>Keypad:</u>	if C50=1, 3 or 4	→	press  for 5";
	if C50=0 or 2	→	the parameter can only be displayed.
<u>Remote control:</u>	if C50=0, 1 or 4	→	direct access pressing "ENABLE" and, after a that, the dedicated buttons;
	if C50=2 or 3	→	the parameter can only be displayed.
<u>Modes:</u>	in all modes except C00=0 and 1 ("SLAVE DIRECT" and "SLAVE REVERSE")		
<u>Operating range:</u>	from 0.0 to 100 (180°F)		
<u>Default:</u>	P27 = 2.0 (3.6°F)		

Note: if the controlled parameter has almost restored its normal values but is still beyond its high or low thresholds, you can cancel the alarm indication pressing . In order not to reset alarms automatically, give P27 a very high value.

P28: Time-delay before generating an alarm

P28 allows you to set a time-delay before the activation of Low/High (temperature, pressure) alarms after the P25 or P26 threshold has been exceeded. It can also be applied to external alarms.

Access:

<u>Keypad:</u>	if C50=1, 3 or 4	→	press  for 5";
	if C50=0 or 2	→	the parameter can only be displayed..
<u>Remote control:</u>	if C50=0, 1 or 4	→	direct access pressing "ENABLE" and, after that, the dedicated buttons;
	if C50=2 or 3	→	the parameter can only be displayed.
<u>Operating range:</u>	from 0 to 999 seconds.		
<u>Default:</u>	P28 = 1 s.		

Note: if the controlled variable returns above the Low threshold alarm P25 or below the High alarm threshold P26 or if the external alarm signal returns to normal values before the time-delay has passed, no alarm will be generated.



8.5 Parameters concerning digital inputs and output

C29: Multifunction digital input ID1

C29 indicates the function of the digital input ID1.

Access:

Keypad:

if C50=1, 3 or 4 →  +  for 5" and password 77;

if C50=0 or 2 → the parameter can only be displayed..

Remote control:

if C50=4 → press "ENABLE" and ▲ and ▼;

Modes:

only when C00=0, 1, 2, 3

Operating range:

from 0 to 5

C29=0 →

input not used

C29=1 →

external alarm and automatic reset (alarm with open input)

C29=2 →

external alarm and manual reset (alarm with open input)

C29=3 →

delayed external alarm and manual reset (alarm with open input; time-delay set by P28)

C29=4 →

On/Off regulation (off when open input): when in the Off status, the analogue output will be immediately disenergized (0 V)

C29=5 →

energization of the 0÷10 V analogue output to 100%: when the input is closed, the analogue output is forced to 0 V.

Default:

C29 = 0 → input not used.



Note: if the function associated with the input ID1 is the same as that associated with the input ID2, **ID1** has priority

C30: Multifunction digital input ID2

C30 indicates the function of the digital input ID2.

Access:

Keypad:

if C50=1, 3 or 4 →  +  for 5" and password 77; if C50=0 or 2 → the param. can only be displayed.

Remote control:

if C50=4 → press "ENABLE" and ▲ and ▼;

Operating range:

from 0 to 5

C30=0 →

input not used

C30=1 →

external alarm and automatic reset (alarm with open input)

C30=2 →

external alarm and manual reset (alarm with open input)

C30=2 →

external alarm and manual reset (alarm with open input)

C30=3 →

delayed external alarm and manual reset (alarm with open input): time-delay set by P28

C30=4 →

On/Off regulation (off when open input): when in the Off status, the analogue output will be immediately disenergized (0 V)

C30=5 →

energization of the 0÷10 V analogue output to 100%: when the input is closed, the analogue output is forced to 0 V.

Default:

C30 = 0 → input not used



Note: if the function associated with the input ID1 is the same as that associated with the input ID2, **ID1** has priority

C31: Multifunction (relay) digital output

C31 indicates the function of the relay digital output (if not differently used according to the selected operating mode).

Access:

Keypad:

if C50=1, 3 or 4 →  +  for 5" and password 77; if C50=0 or 2 → the param. can only be displayed..

Remote control:

if C50=4 → press "ENABLE" and ▲ and ▼;

Modes:

not available when C00=8

Operating range:

from 0 to 8

C31=0 →

output not used (disenergized relay)

C31=1 →

disenergized relay in the event of generic alarm

C31=2 →

energized relay in the event of generic alarm

C31=3 →

disenergized relay in the event of active analogue output

C31=4 →

energized relay in the event of active analogue output

C31=5 →

disenergized relay when the analogue output has its max. value (hysteresis 0.5 V)

C31=6 →

energized relay when the analogue output has its max. value (hysteresis 0.5 V)

C31=7 →

disenergized relay when the analogue output reaches its max. value; energized relay when the analogue output reaches its min. value (On/Off regulation)

C31=8 →

energized relay when the analogue output reaches its max. value; disenergized relay when the analogue output reaches its min. value (On/Off regulation).

Default:



C31 = 0 → output not used.

8.6 Parameters concerning the unit of measure

C32: Displaying the unit of measure

C32 defines if and when it is necessary to display the unit of measure.

Access:

Keypad: if C50=1, 3 or 4 →  +  for 5" and password 77;
if C50=0 or 2 → the parameter can only be displayed..
Remote control: if C50=4 → press "ENABLE" and ▲ and ▼;

Operating range:

from 0 to 3 when using pressure probes with specified refrigerant
from 0 to 2 in the other cases

C32=0 → display always disabled
C32=1 → display enabled only when accessing the parameters, except set-points
C32=2 → display always enabled
C32=3 → display always enabled; display of the variable in bar only



Default: C32 = 2 → display always enabled..

Note: when C32=3 it is possible to manage all the parameters concerning that variable in degrees and to display the measure of the probes in bar. We suggest using this mode only to test the instrument during installation.

C33: Normally displayed value

C33 defines the indications normally displayed when you are not programming the instrument.

Access:

Keypad: if C50=1, 3 or 4 →  +  for 5" and password 77;
if C50=0 or 2 → the parameter can only be displayed..
Remote control: if C50=4 → press "ENABLE" and ▲ and ▼;

Operating range:

from 0 to 5

C33=0 → displays the actual measure depending on C19
C33=1 → displays the measure of probe 1 (main probe)
C33=2 → displays the measure of probe 2 (secondary probe)
C33=3 → displays the % value of the analogue output
C33=4 → displays the % value of the input of probe 1
C33=5 → displays the status of the digital inputs and outputs (starting from the left you can see the status of input ID1, ID2 and of the output; 0 indicates the 'off' status, 1 the 'on' status).

Default: C33 = 1 → measure of probe 1.

Note: C33=4 has some meaning only in models FCM0001000 and FCM0002000 working in the SLAVE mode where it makes the instrument display the command signal in %. In the FCM00NTC00 model zero will be displayed.

P34: Displaying the actual measure depending on C19

The parameter can only be displayed.

Access:

Keypad: press  for 5 seconds
Remote control: immediate display using the dedicated button.

P35: Displaying the measure of probe 1 (main probe)

The parameter can only be displayed.

Access:

Keypad: immediate display holding down ▲ or  for 5 seconds;
Remote control: immediate display using the dedicated button.

P36: Displaying the measure of probe 2 (secondary probe)

The parameter can only be displayed.

Access:

Keypad: immediate display holding down ▼ or  for 5 seconds;
Remote control: immediate display using the dedicated button.

P37: Displaying the % value of the analogue output

The parameter can only be displayed.

Access:

Keypad: press  for 5 seconds;
Remote control: immediate display using the dedicated button.

P38: Displaying the % value of the input of probe 1

The parameter can only be displayed.

Access:

Keypad: press  for 5 seconds;
Remote control: press "ENABLE" and ▲ and ▼

Note: P38 has some meaning only in models FCM0001000 and FCM0002000 working in the SLAVE mode where it makes the instrument display the command signal in %. In the FCM00NTC00 model zero will be displayed.

P39: Displaying the status of digital inputs and outputs

The parameter can only be displayed. It shows the status of input ID1, ID2 and of the output: 0 → off status;
1 → on status;

Access:

Keypad: press  for 5 seconds;
Remote control: press "ENABLE" and ▲ and ▼;
Operating range: from 00.0 to 11.1

8.7 Parameters concerning defrost

P40: Defrost threshold

P40 indicates the threshold below which defrost starts. It is an absolute value.

Access:

Keypad: if C50=1, 3 or 4 → press  for 5 seconds;
if C50=0 or 2 → the parameter can only be displayed.
Remote control: if C50=0, 1 or 4 → press "ENABLE" and ▲ and ▼;
if C50=2 or 3 → the parameter can only be displayed.
Modes: only when C00=8
Operating range: from -40 to P41 for temperature probes or pressure probes with specified refrigerant in °C (C18=0) or °F (C18=1);
from 0.0 to P41 for humidity probes in rH (C18=2) or pressure probes with specified refrigerant, in bar.

Default: P40 = 0.0 (32.0°F).

Note: defrost depends also on the time-delay selected through the parameter P42 and on the minimum time-interval between two defrosting cycles selected through P44.

P41: Threshold defining the end of defrost cycle

P41 defines the threshold above which defrost ends. It is an absolute value.

Access:

Keypad: if C50=1, 3 or 4 → press  for 5 seconds;
if C50=0 or 2 → the parameter can only be displayed.
Remote control: if C50=0, 1 or 4 → press "ENABLE" and ▲ and ▼;
if C50=2 or 3 → the parameter can only be displayed.
Modes: only when C00=8.
Operating range: from P40 to 100 for temperature probes or pressure probes with specified refrigerant in °C (C18=0);
from P40 to 212 for temperature probes or pressure probes with specified refrigerant in °F (C18=1);
from P40 to 100 for humidity probes in rH (C18=2) or pressure probes with unspecified refrigerant in bar.
Default: P41 = 100 (212°F) - threshold excluded.

Note: the defrost cycle may come to an end also when the max. time-interval selected through P43 has passed. In this case a dedicated message will be displayed. P41 can be excluded giving it its max. value (in this case the defrost cycle will always end when its max. duration has passed, without any message on the display).

P42: Time-delay before starting a defrost cycle

P42 defines the time-delay before starting a defrost cycle, after the threshold set through P40 has been exceeded.

Access:

Keypad: if C50=1, 3 or 4 → press  for 5 seconds;
if C50=0 or 2 → the parameter can only be displayed.
Remote control: if C50=0, 1 or 4 → press "ENABLE" and ▲ and ▼;
if C50=2 or 3 → the parameter can only be displayed.
Modes: only when C00=8
Operating range: from 0 to 240 (seconds).
Default: P42 = 5 s.

Note: if the value goes above the P40 threshold before the end of the time-delay, the delay will be zeroed .

P43: Max. duration of defrost

P43 defines the max. duration of a defrost cycle.

Access:

<i>Keypad:</i>	if C50=1, 3 or 4	→	press  for 5”;
	if C50=0 or 2	→	the parameter can only be displayed.
<i>Remote control:</i>	if C50=0, 1 or 4	→	press “ENABLE” and ▲ and ▼;
	if C50=2 or 3	→	the parameter can only be displayed.
<i>Modes:</i>	only when C00=8		
<u>Operating range:</u>	from 1 to 60 minutes.		
<u>Default:</u>	P43 = 1 minute.		

Note: if the P41 threshold has been excluded, P43 sets the fixed time for a defrost cycle. When P41 is operative P43 defines the max. time beyond which the defrost cycle will come to an end; the display will then show a message.

P44: Min. time-interval between two defrost cycles

P44 sets the min. time-interval between a defrost cycle and the next one.

Access:

<i>Keypad:</i>	if C50=1, 3 or 4	→	press  for 5 seconds;
	if C50=0 or 2	→	the parameter can only be displayed.
<i>Remote control:</i>	if C50=0, 1 or 4	→	press “ENABLE” and ▲ and ▼;
	if C50=2 or 3	→	the parameter can only be displayed.
<i>Modes:</i>	only when C00=8		
<i>Other parameters:</i>	does not depend on other parameters.		
<u>Operating range:</u>	from 1 to 240 minutes.		
<u>Default:</u>	1 minute.		

Note: if the duration of the defrost cycle (P43) is greater than or equal to P44, the defrost will go on provided that the value of the variable remains below P40.

P45: Value of the output during defrost

P45 sets the value of the 0÷10 V analogue output during a defrost cycle.

Access:



<i>Keypad:</i>	if C50=1, 3 or 4	→	press  for 5 seconds;
	if C50=0 or 2	→	the parameter can only be displayed.
<i>Remote control:</i>	if C50=0, 1 or 4	→	press “ENABLE” and ▲ and ▼;
	if C50=2 or 3	→	the parameter can only be displayed.
<i>Modes:</i>	only when C00=8.		
<i>Other parameters:</i>	does not depend on other parameters.		
<u>Operating range:</u>	from 0 to 100%.		
<u>Default:</u>	P45 = 0.		

8.8 Parameters concerning keypad and remote control

C50: Enabling keypad and remote control

C50 allows you to limit or prevent any modification of the parameters by non authorized personnel.



Access:

<i>Keypad:</i>	 +  for 5 seconds and password 77;		
<i>Remote control:</i>	if C50=4	→	press “ENABLE” and ▲ and ▼.
<i>Other parameters:</i>	does not depend on other parameters.		
<u>Operating range:</u>	from 0 to 4		
C50=0	→	Keypad:	disabled (parameters can be only displayed except C50)
		Remote control:	parameters P and set-point can be modified, parameters C can't be seen;
C50=1	→	Keypad:	enabled;
		Remote control:	parameters P and set-points can be modified; parameters C can't be seen;
C50=2	→	Keypad:	disabled (only displayed parameters, except C50);
		Remote control:	disabled (parameters P and set-point can only be displayed);
C50=3	→	Keypad:	enabled;
		Remote control:	disabled (parameters P and set-point can only be displayed);
C50=4	→	Keypad:	enabled;
		Remote control:	enabled;
<u>Default:</u>	C50 = 4	→	Keypad and remote control enabled.

C51: Code enabling the remote control

C51 allows you to give each controller a code to access parameters via remote control. If your control panel comprises several instruments, press "ENABLE" on the remote control to give each instrument a different access code.

Access:

<u>Keypad:</u>	if C50=1, 3 or 4	→	 +  for 5 seconds and password 77;
	if C50=0 or 2	→	the parameter can only be displayed.
<u>Remote control:</u>	if C50=4	→	press "ENABLE" and ▲ and ▼.
<u>Operating range:</u>	from 0 to 99		
<u>Default:</u>	C51 = 0	→	code disabled



Note: if the code is not operative (C51=0) the identification procedure will fail. When you use the buttons of the remote control to display values, all instruments will display what you have selected, independently of their identification code (unless you are programming the instruments).

8.9 Parameters concerning serial connection

C52: Type of serial connection

C52 enables and defines the type of serial connection.

Access:



<u>Keypad:</u>	if C50=1, 3 or 4	→	 +  for 5 seconds and password 77;
	if C50=0 or 2	→	the parameter can only be displayed.
<u>Remote control:</u>	if C50=4	→	press "ENABLE" and ▲ and ▼.
<u>Operating range:</u>	from 0 to 2		
C52=0	→		disabled connection
C52=1	→		connection to supervisory network (protocol Supervisor 3.0)
C52=2	→		connection to pLAN network
<u>Default:</u> C52 = 1	→		supervisory network

Note: using the serial connection requires the **FCSER00000** option. Any modification of this parameter will become operative after you have turned the instrument on again.

C53: Serial address

C53 gives each device a specific address. All data with address equal to C53 are accepted by the device.

Access:

<u>Keypad:</u>	if C50=1, 3 or 4	→	 +  for 5 seconds and password 77;
	if C50=0 or 2	→	the parameter can only be displayed.
<u>Remote control:</u>	if C50=4	→	press "ENABLE" and ▲ and ▼.
<u>Operating range:</u>	from 0 to 255.		
<u>Default:</u>	C53 = 0.		



Note: using the serial connection requires the **FCSER00000** option. The pLAN network makes use of addresses ranging from 1 to 32.

C54: Baud-rate / data destination address

Depending on the type of connection, C54 may define:

- supervision: transmission speed (baud-rate);
- pLAN: the address of the instrument to which data are sent.

Access:

<u>Keypad:</u>	if C50=1, 3 or 4	→	 +  for 5 seconds and password 77;
	if C50=0 or 2	→	the parameter can only be displayed.
<u>Remote control:</u>	if C50=4	→	press "ENABLE" and ▲ and ▼.
<u>Other parameters:</u>	depends on C52.		
<u>Operating range:</u>	from 0 to 3 if C52=1 (supervisor)		
C54=0	→		1200 Bd
C54=1	→		2400 Bd
C54=2	→		4800 Bd
C54=3 (o > 3)	→		9600 Bd
			from 0 to 32 if C52=2 (pLAN)

Default: C54 = 0.



Note: using the serial connection requires the **FCSER00000** option. Any modification of this parameter will become operative after you have turned the instrument on again (connection to supervisory network only).

C55: Frame / page

Depending on the communication protocol, C55 defines:

- supervision: data structure (frame);
- pLAN: the page of the device where data will be received.

Access:

Keypad: if C50=1, 3 or 4 →  +  for 5 seconds and password 77;

if C50=0 or 2 → the parameter can only be displayed.

if C50=4 → press "ENABLE" and ▲ and ▼.

Remote control:

Other parameters:

depends on C52.

Operating range:

from 0 to 11 if C52=1 (supervision)

C55=0 → 8 bit/character, no parity, 2 stopbits (8,N,2)

C55=1 → 8 bit/character, no parity, 1 stopbit (8,N,1)

C55=2 → 8 bit/character, even parity, 2 stopbit (8,E,2)

C55=3 → 8 bit/character, even parity, 1 stopbit (8,E,1)

C55=4 → 8 bit/character, odd parity, 2 stopbit (8,O,2)

C55=5 → 8 bit/character, odd parity, 1 stopbit (8,O,1)

C55=6 → 7 bit/character, no parity, 2 stopbit (7,N,2)

C55=7 → 7 bit/character, no parity, 1 stopbit (7,N,1)

C55=8 → 7 bit/character, even parity, 2 stopbit (7,E,2)

C55=9 → 7 bit/character, even parity, 1 stopbit (7,E,1)

C55=10 → 7 bit/character, odd parity, 2 stopbit (7,O,2)

C55=11 (o > 11) → 7 bit/character, odd parity, 1 stopbit (7,O,1), from 0 to 255 if C52=2 (pLAN)



Default: C55 = 0.

Note: using the serial connection requires the **FCSER00000** option. Any modification of this parameter will become operative after you have turned the instrument on again (connection to supervisory network only).

C56: Delayed response

C56 is used only when the controller is connected to a supervisory network. It allows you to set a time-delay before sending back data so as to let the calling device take time to commute itself from a transmitter to a receiving unit.

Access:

Keypad: if C50=1, 3 or 4 →  +  for 5 seconds and password 77;

if C50=0 or 2 → the parameter can only be displayed..

if C50=4 → press "ENABLE" and ▲ and ▼;

Remote control:

Operating range:

from 0 to 200 milliseconds.



Default: C56 = 50 milliseconds.

Note: using the serial connection requires the **FCSER00000** option.

C57: Enabling the hardware board

C57 allows you to eliminate some functions from the hardware board and manage them via serial connection.

Access:

Keypad: if C50=1, 3 or 4 →  +  for 5 seconds and password 77;

if C50=0 or 2 → the parameter can only be displayed.

if C50=4 → press "ENABLE" and ▲ and ▼.

Remote control:

Operating range:

from 0 to 255.

bit0 (weight 1) → 1=display controlled by user interface;

0=display idle or controlled via serial line;

bit1 (weight 2) → 1=input ID1 controlled by terminal block;

0=input ID1 idle or controlled via serial line;

bit2 (weight 4) → 1=input ID2 controlled by terminal block;

0=input ID2 idle or controlled via serial line;

bit3 (weight 8) → 1=relay output controlled by terminal block;

0=relay output idle or controlled via serial line;

bit4 (weight 16) → 1=B1 probe input controlled by terminal block;

0=B1 probe input idle or controlled via serial line;

bit5 (weight 32) → 1=B2 probe input controlled by terminal block;

0=B2 probe input idle or controlled via serial line;

bit6 (weight 64) → 1=0÷10 V output (soft-start) controlled by terminal block;

0=0÷10 V output (soft-start) idle or controlled via serial line;

bit7 (weight 128) → not used.

Default: C57 = 255 → fully enabled.

Note: if you set C57 different from 255, some functions will not be performed. For example, if during normal operation the 0÷10 V output is at 9 V and C57 is modified from 255 to 127 (255-128), then the 0÷10 V output will stick to 9 V independently of any value given to the parameters, of any signal or external command (except, obviously, when C57=255).

9 Table of Parameters

	Parameter	Min	Max	Def	U.M.	Nuovi
	PASSWORD			77	-	
	PARAMETERS CONCERNING THE SET-POINT					
<i>St1</i>	(*) Set-point 1 (main)	-40	100	0.0	°C	
		0.0	100		r.H./bar	
<i>St2</i>	(*) Set-point 2 (secondary) - <i>parameter accessible only if C00=5, 6, 7, 8</i>	-40	100	0.0	°C	
		0.0	100		r.H./bar	
<i>C00</i>	Operating mode: 0= Slave direct 1= Slave reverse 2= Direct 3= Reverse 4= Dir. & Rev. (from input ID1) 5= Dir-St1 & Dir-St2 (from input ID1) 6= Rev-St1 & Rev -St2 (from input ID1) 7= Dir-St1 & Rev-St2 (from input ID1) 8= Dir.-St1 & Rev-St2-Defrost (from ID1)	0	8	2	-	
<i>P01</i>	(*) Differential of St1	0.0	100	2.0	°C/r.H./bar	
<i>P02</i>	(*) Differential of St2 - <i>parameter accessible only if C00=5, 6, 7, 8</i>	0.0	100	2.0	°C/r.H./bar	
<i>C03</i>	(*) Type of Set-point 0=Set-point corresponding to the min. output value 1=Set-point corresponding to the average output value 2=Set-point corresponding to the max. output value	0	2	0	-	
	ANALOGUE OUTPUT					
<i>C04</i>	Min. output value	0	C05	0	%	
<i>C05</i>	Max. output value	C04	100	100	%	
<i>C06</i>	Soft-start	0	120	2	s	
<i>C07</i>	(*) Cut-off	0.0	100	0.0	-	
<i>C08</i>	(*) Speed-up	0	120	0	s	
<i>C09</i>	(*) Integral action	0	999	0	s	
<i>C10</i>	Output value with disconnected probe or High alarm 0=discon. probe: disabled out. (0%), High(Low) alarm: normal output 1=discon. probe: output at C04 (min value), High(Low) alarm: normal output 2=discon. probe: out. at C05 (max value), High(Low) alarm: normal output 3=discon. probe: disabled out. (0%), High(Low) alarm: out. at 100% 4=discon. probe: out. at C04 (min value), High(Low) alarm: out. at 100% 5=discon. probe: out. at C05 (max value), High(Low) alarm: out. at 100%	0	5	0	-	

INPUTS						
C13	Probe type					
	FCM00NTC00 = 0= NTC probes (10 kΩ at	0	0	0		-
	FCM0001000 = 1=0÷10V probes for Temp. or Humidity	1	2	1		
FCM0002000 = 2=0÷10 V probes for Pressure						
	3=0÷20 mA probes for T. or H.	3	6	6		
	4=0÷20 mA probes for P.					
	5=4÷20 mA probes for T. or H.					
	6=4÷20 mA probes for P.					
7=Carel 4÷20 mA probes for Temp. and Humidity						
C14*	Type of refrigerant - <i>accessible only when C13=2, 4, 6</i> 0=unspecified refrigerant; 1=R22, 2=R404a, 3=R407, 4=R134a, 5=R410a, 6=R290 (propane), 7=NH ₃ (ammonia)	0	7	0		-
C15*	Min. value for current or voltage inputs. <i>Not accessible when C13=0</i>	-40	C16	0.0		°C
		0.0	C16			r.H./bar
C16*	Max. value for current or voltage inputs, <i>not accessible when C13=0</i>	C15	100	100 (**)		°C/r.H./bar
C17	Filtering action at probe input	0,0	10,0	1.0		s
C18*	Unit of measure: 0=°C, 1=°F, 2=rH - <i>parameter not accessible when C13=2, 4, 6 and C14=0</i>	0	2	0		-
C19*	Second probe management	0	4	0		-
	0=second probe not used (disconnected input)					
	1=actual measure = the greater of the two probes (the lower in "reverse" mode)					
	2=actual measure = the lower of the two probes (the greater in "reverse" mode)					
3=actual measure = difference between probe 1 and probe 2						
4=probe 2 used to control defrost cycles						
ALARMS						
P25*	Threshold of Low (T., P..) alarm	-40	P26	-40 (***)		°C
		0.0	P26			r.H./bar
P26*	Threshold of High (T., P..) alarm	P25	100	100		°C/r.H./bar
P27*	Differential of High and Low Alarm	0.0	100	2.0		°C/r.H./bar
P28	Delayed alarm	0	999	1		s
DIGITAL INPUTS and OUTPUTS						
C29	Multi-function digital input ID1 (for the codes: see C30 parameter) <i>parameter accessible only if C00=0, 1, 2, 3.</i>	0	5	0		
C30	Multi-function digital input ID2	0	5	0		-
	0=input not used 1=external alarm and automatic reset (alarm with open input)					
	2=ext. alarm and manual reset (alarm with open input)					
	3=delayed external alarm and manual reset (alarm with open input; time-delay defined by P28))					
	4=On/Off regulation (off with open input) in case of off, the analogue out. dis-energises immediately (0 V)					
5=0÷10 V analogue out. Energises to 100%; in case of closed input, the analogue out. is forced to 10V.						

C31	Multi-function digital output (relay) - <i>parameter not accessible when defrost is enabled (C00=8)</i> 0=output not used (disenergized relay) 1=disenergized relay in the event of generic alarm 2=energized relay in the event of generic alarm 3=disenergized relay in the event of active analogue output 4=energized relay in the event of active analogue output 5=disenergized relay when the analogue output has its max. value (hysteresis 0.5 V) 6=energized relay when the analogue output has its max. value (hysteresis 0.5 V) 7=disenergized relay when the analogue output reaches its max. value; energized relay when the analogue output reaches its min. value (On/Off regulation) 8=energized relay when the analogue output reaches its max. value; disenergized relay when the analogue output reaches its min. value (On/Off regulation).	0	8	0	-	
PARAMETERS CONCERNING THE CONTROLLED VARIABLE						
C32	Displaying the unit of measure: 0= disabl., 1=enabled, only when accessing parameters, Set-point excluded 2=always enabled, 3= always enabled, displaying measures in bar only.	0	3	2	-	
C33	Normally displayed value: 0=actual measure related to C19, 1=measure of probe 1 (main probe); 2= measure of probe 2 (secondary); 3= % value of analogue output; 4= % value of probe 1 input 5= status of digital I/O	0	5	1		
P34	Displaying the actual measure (depending on C19)	-	-	-	-	
P35	Displaying value of probe 1 (main probe)	-	-	-	-	
P36	Displaying value of probe 2 (secondary probe)	-	-	-	-	
P37	Displaying % value of analogue output	-	-	-	-	
P38	Displaying % value of probe 1 input	-	-	-	-	
P39	Displaying status of digital inputs and outputs	00.0	11.1	-	-	

PARAMETERS CONCERNING DEFROST <i>Accessible only when C00=8</i>						
P40*	Defrost threshold causing defrost to start	-40	P41	0.0	°C	
		0.0	P41		r.H./bar	
P41*	Defrost threshold causing defrost to end	P40	100	100	°C/r.H./bar	
P42*	Time-delay before defrost end	0	240	5	secondi	
P43*	Max. duration of defrost	1	60	1	minuti	
P44*	Min. time-interval between 2 defrost cycles	1	240	1	minuti	
P45*	Output value during defrost	0	100	0	%	

PARAMETERS CONCERNING KEYPAD/REMOTE CONTROL						
C50	Enabling Keypad and Remote control: 0=keypad disabled; rem.control: param. P and St1 can be modified, par. C can't be seen. 1=keypad enabled; rem. control: param. P and St can be modified, param. C can't be seen. 2= keypad disabled; rem.control disabled (param. P and St can only be displayed). 3=keypad enabled; rem. control disabled (param. P and St can only be displayed). 4=keypad enabled; rem.control enabled.	0	4	4	-	
C51	Code to enable the remote control	0	99	0	-	
PARAMETERS CONCERNING SERIAL CONNECTION						
C52	Type of serial connection: 0=no connection 1=supervisory network (protocol Supervisor 3.0) 2=connection to pLAN network	0	2	1	-	
C53	Serial address	0	255	0	-	
C54	Baud-rate (if C52=1); 0=1200 Bd, 1=2400 Bd, 2=4800 Bd, 3=9600 Bd Data destination address	0	3	0	-	
		0	32	0		
C55	Frame (if C52=1) 0= (8,N,2) 1= (8,N,1) 2= (8,E,2) 3= (8,E,1) 4= (8,O,2) 5= (8,O,1) 6=(7,N,2) 7=(7,N,1) 8= (7,E,2) 9= (7,E,1) 10= (7,O,2) 11 (and beyond)= (7,O,1)	0	11	0	-	
		0	255			
C56	Delayed response	0	255	50	ms	
C57	Enabling hardware board	0	255	255	%	

Default = factory-set value;

- (*) parameters not accessible in SLAVE mode
- (**) for FCM0002000 default is 30.0
- (***) for FCM0002000 default is 0.0

10 Alarms

The instrument controls and constantly checks alarm conditions during unit operating. In the event of off-normal condition:

- when not in the programming phase, the display shows a message that identifies the type of alarm (see table below). The alarm message is shown alternatively to the normally displayed parameter every two seconds; in the event the regulator has interrupted control action or other alarms have been detected, the display will show the symbol "---" as well as the other alarm indications. If the normally displayed value is that of a probe temporarily disconnected, it won't be displayed until the probe has been connected again (the probe value will then be shown alternatively to the dedicated alarm message);
- the buzzer sounds, except in the event of EdF alarm;
- the status of the controller and its analogue output depend on the type of alarm occurred;
- the starting up of the relay digital output (if programmed as alarm indication) depends on the type of alarm.

When the cause that generated the alarm disappears, the controller and the digital output **can be reset automatically or manually**, depending on the type of alarm. Turning off the buzzer and resetting the alarm message requires a manual operation (except for alarms Er4, Er5 and EdF). Press PRG once to silence the buzzer and twice to make the displayed alarm message disappear.

Should an alarm be detected while displaying or modifying a parameter, press PRG to silence the buzzer. After that, PRG can be used to save any modification and exit the programming procedure.

Type of alarm	Effects on the regulation process	Effects on the digital output (when C31=1,2)	Reset
Er0 disconnected probe 1	regulation is disabled and analogue output is determined by C10 (while defrosting, the regulation continues normally until the programmed max. defrost time has passed)	energised	automatic as soon as the probe is reconnected; manual reset for buzzer and displayed messages
Er1 disconnected probe 2 (if C19 is different from 0)	the same as Er0 (if C19=4 without defrost, the regulation process will go on normally)		
Er2 faulty parameter memory	disabled with analogue output to 0 V	none	Re-programming
Er3 alarm from digital input	disabled with analogue output to 0 V	energised	programmable: both manual and automatic as soon as the external alarm stops; manual reset for buzzer and displayed messages
Er4 High alarm	determined by C10 (no effects or analogue out at 100%)	energised	automatic with program. Differential; (manual if the differential has been given a high value)
Er5 Low alarm			
EdF Max. defrost time	none	none (not available)	automatic reset if the next cycle is carried out correctly

The Er2 alarm will be shown permanently on the display due to:

- faulty reading of the parameters memory (usually at start-up); factory-set parameters will be temporarily set but they will not be saved in the parameters memory (it is possible, however, to access to the parameters and set their correct values again). We suggest resetting the factory-set parameters.
- faulty writing of the parameters memory (usually when pressing PRG). Any new modification won't be saved; it is possible, however, to access to the parameters, modify their values and save them again.

Press  to silence the buzzer and cancel the alarm message on the display.

Alarms Er3, Er4 and Er5 will not appear if there is a disabling command coming from terminal block.

11 Technical specifications

Power supply	24 Vac/dc, -20%, +10%, 50/60Hz. In case of alternating current, use a 10V transformer at least	
Absorbed power	3 VA	
Operating range	temperature	-40T100 (-40÷100°C; -40÷212°F)
	pressure	0.0÷100 bar
	humidity	0,0÷100% rH
Precision	FCM00NTC00	1°C within the range -10÷100°C, 14÷212°F 2°C within the range -40÷-10°C, -40÷14°F
	FCM000*000	1% of full scale
Resolution	FCM00NTC00	0.1°C(°F) within the range -9.9÷99, 9°C(°F); 1°C(°F) otherwise
	FCM000*000	max 0.1% of full scale; min 0,1 within the range -9.9/ 99.9; 1 otherwise
Storage conditions	-10T70 (-10÷70°C, 14÷158°F), below 90% rH non condensing	
Operating conditions	0T50 (0÷50°C, 32÷122°F), below 90% rH non condensing	
External fuse (obligatory)	315 mA T	
Mounting	DIN rail	
Case	Plastic: dimensions 72x88x64 mm	
Index of protection	IP20 (IP40 with panel mounting)	
Connections	Screw terminals for wires with max. 1.5 mm ² /min. 0.5 mm ² cross-section	
Classification for protection against electrical shocks	Class II <u>Low tension</u> components have reinforced insulation if compared to <u>very low tension</u> ones. There is supplementary insulation between very low tension components and the front panel. The very low tension components (probe inputs, digital inputs, serial connection and power supply) do not have any insulation.	
Number of cycles of automatic operations (i.e.: relays)	100,000	
Obsolescence (working hours)	60,000 hours	
Type of action of micro switches	Type 1C complying with ECC EN 60730-1 standards	
PTI insulation material	250V	
Time during which insulation components undergo electrical stress	Long	
Ambient pollution	Normal	
Resistance to heat and fire	Category D (self-extinguishing complying with UL94-V0)	
Immunity against over voltage	Category II	
Class and structure of the Software	Class A	
Analogue inputs	FCM00NTC00	2 for probes NTC CAREL 10 kΩ at 25°C (response time depends on the type of component)
	FCM0001000	2 0÷10 V inputs (min. response time 100 ms)
	FCM0002000	2 0÷20 mA or 4÷20 mA inputs (min. response time 100 ms)
Digital inputs	2 voltage free, programmable by the user: <ul style="list-style-type: none"> • max. voltage with open contact 5Vdc • max. current with closed contact 5mA • max. resistance 50 Ω 	
Analogue output	1 at 0÷10 V; I _{max} =5 mA, min. load 2 kΩ; precision 1% of full scale	
Digital output	1 SPDT relay-programmable by the user: I _{max} =8 A res.(2A), V _{acmax} =250 V	
Aux. Power supply output (for probes)	12 Vdc, +10%, I _{max} =50 mA total	
Serial line (optional)	2-lead RS-485	
Display	3 digits, 7-segment LED indicators	
Indications	LED for active analogue output and special function	

12 Wiring diagram

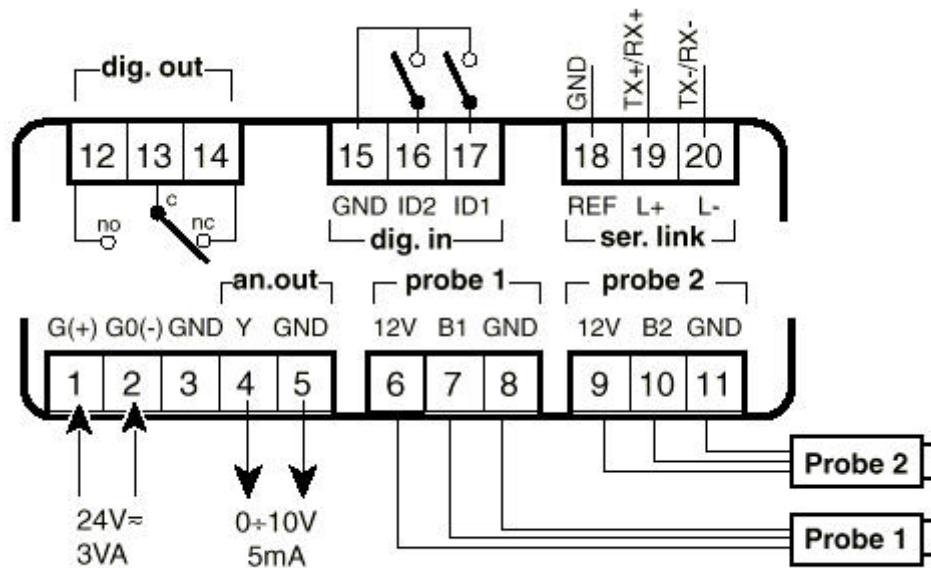

12.1 Terminal block

Terminal	Symbol	Description
1	G(+)	Power supply (positive pole when dc voltage)
2	G0(-)	Power supply (negative pole when dc voltage)
3	GND	Cable shielding
4	Y	0÷10Vdc analogue output
5	GND	GND for 0÷10Vdc analogue output
6	+12V	Auxiliary power supply
7	B1	Input probe 1
8	GND	GND for input probe 1
9	+12V	Auxiliary power supply
10	B2	Input probe 2
11	GND	GND for input probe 2
12	NO	Relay output: normally open contact
13	C	Relay output: common
14	NC	Relay output: normally closed contact
15	GND	Common for digital inputs
16	ID2	Digital input 2
17	ID1	Digital input 1
18	REF	Serial line RS-485: reference
19	TX+/RX+	Serial line RS-485: positive pole
20	TX-/RX-	Serial line RS-485: negative pole

Terminals G0(-) and GND are internally connected between them.

Terminal REF is internally connected to G0 and GND by a 22Ω resistance.

12.2 Power supply:

- alternate voltage: half-wave rectification stage (should you use a dedicated transformer to power the regulator, keep into consideration an increase - at least three times over - in heating due to the unbalance load of the rectifier).
- continuous voltage: polarity inversion will not damage the instrument but rather prevent it from functioning.

12.3 Connecting probes

NTC Probes

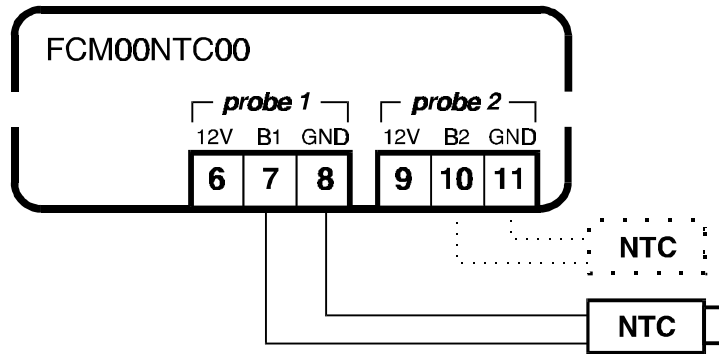

Generator 0÷10 V probes

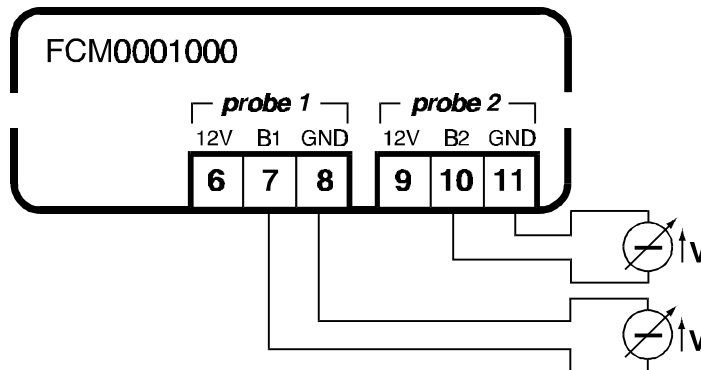

Potentiometer 0÷10 V probes (with separate external supply)

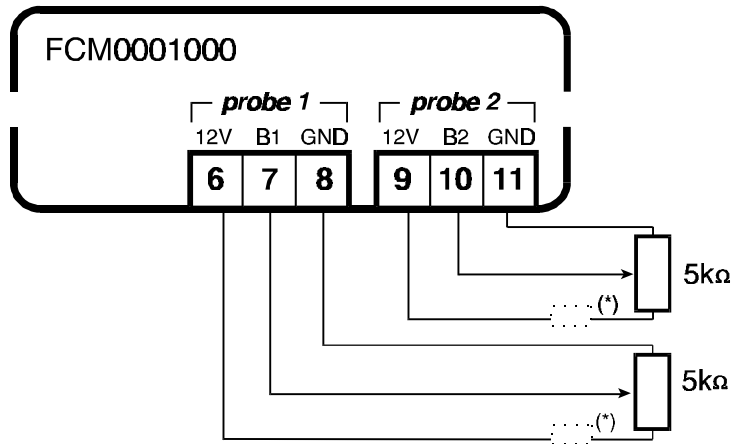

(*) It is recommended to connect an 820Ω resistor in series

Generator 0÷20mA o 4÷20mA probes (with separate external supply)

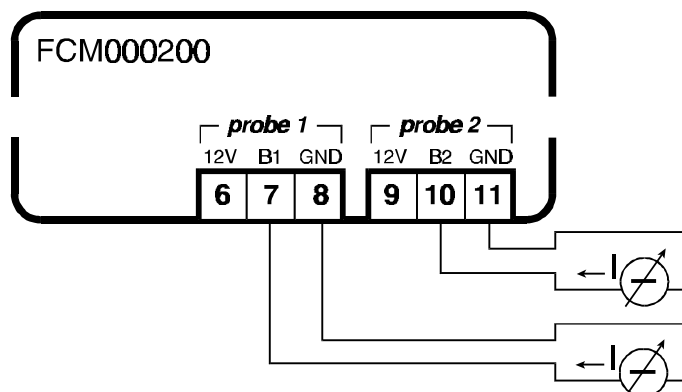

SPK-type 0÷20mA o 4÷20mA SPK probes (Carel pressure probes)

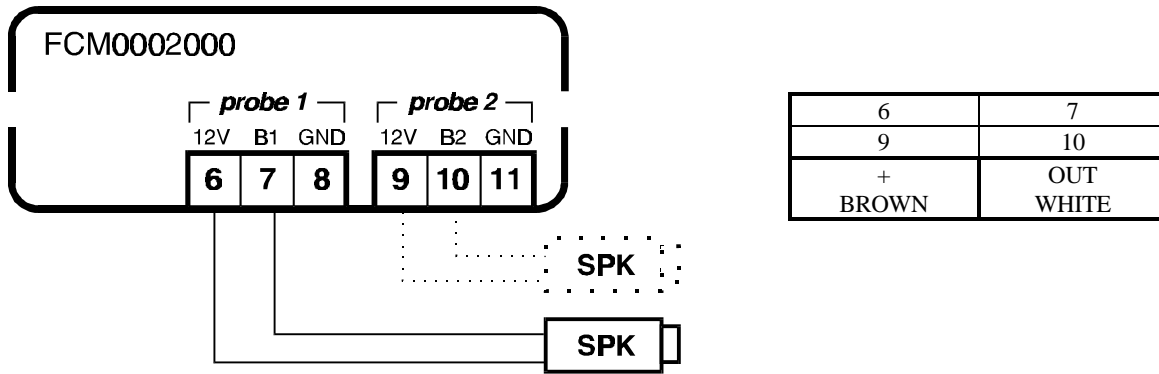

0÷20mA or 4÷20mA AS* probes (Carel temperature/humidity active probes)

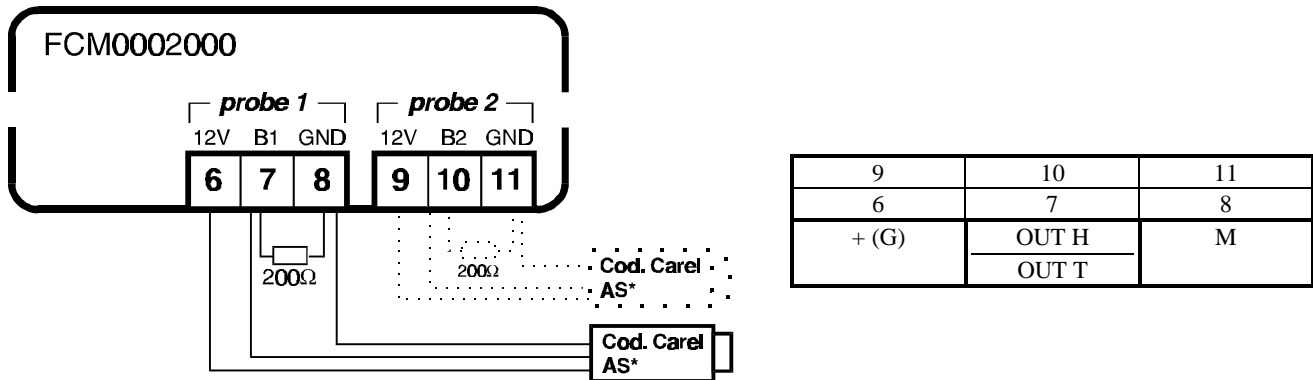

Note: using a probe, it is possible to inhibit the R200 Ω resistance connection, if the 7-B1 and 10-B2 terminals are bridged.

13 Dimensions

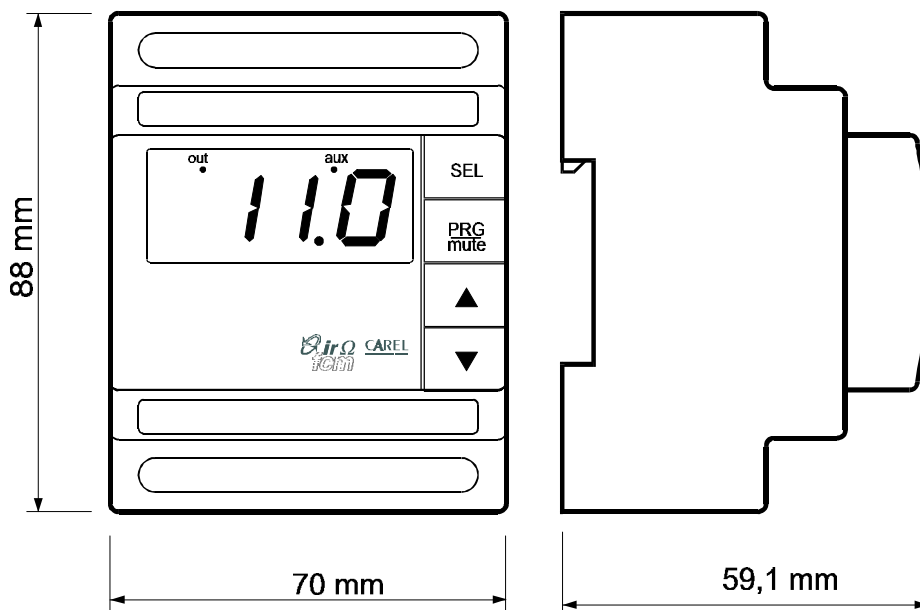

Carel reserves the right to modify the features of its products without prior notice.